

owner's manual

Quality Uncompromised

ROTEL®

RX-845

AM/FM STEREO RECEIVER

ENGLISH	1
DEUTSCH	6
FRANCAIS	11

WARNING

**TO PREVENT FIRE OR SHOCK HAZARD,
DO NOT EXPOSE THIS APPLIANCE TO
RAIN OR MOISTURE**

Write your SERIAL NUMBER here.

The number is located near the name
plate on the rear panel.

SAFETY INSTRUCTIONS

Warning: To reduce the risk of fire or electric shock, do not expose this appliance to rain or moisture.

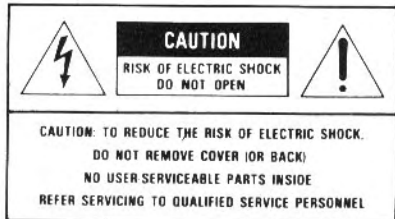

The lightning flash with arrowhead symbol, within an equilateral triangle, is intended to alert the user to the presence of uninsulated "dangerous voltage" within the product's enclosure that may be of sufficient magnitude to constitute a risk of electric shock to persons.



The exclamation point within an equilateral triangle is intended to alert the user to the presence of important operating and maintenance (servicing) instructions in the literature accompanying the appliance.

"Note to CATV system installer:

This reminder is provided to call the CATV system installer's attention to Article 820-22 of the NEC that provides guidelines for proper grounding and, in particular, specifies that the cable ground shall be connected to the grounding system of the building, as close to the point of cable entry as practical."

- Read Instructions** — All the safety and operating instructions should be read before the appliance is operated.
- Retain Instructions** — The safety and operating instructions should be retained for future reference.
- Heed Warnings** — All warnings on the appliance and in the operating instructions should be adhered to.
- Follow Instructions** — All operating and use instructions should be followed.
- Water and Moisture** — The appliance should not be used near water — for example, near a bathtub, washbowl, kitchen sink, laundry tub, in a wet basement, or near a swimming pool, and the like.
- Carts and Stands** — The appliance should be used only with a cart or stand that is recommended by the manufacturer.
- Wall or Ceiling Mounting** — The appliance should be mounted to a wall or ceiling only as recommended by the manufacturer.
- Ventilation** — The appliance should be situated so that its location or position does not interfere with its proper ventilation. For example, the appliance should not be situated on a bed, sofa, rug, or similar surface that may block the ventilation openings; or, placed in a built-in installation, such as a bookcase or cabinet that may impede the flow of air through the ventilation openings.
- Heat** — The appliance should be situated away from heat sources such as radiators, heat registers, stoves, or other appliances (including amplifiers) that produce heat.
- Power Sources** — The appliance should be connected to a power supply only of the type described in the operating instructions or as marked on the appliance.
- Grounding or Polarization** — The precautions that should be taken so that the grounding or polarization means of an appliance is not defeated.
- Power-Cord Protection** — Power-supply cords should be routed so that they are not likely to be walked on or pinched by items placed upon or against them, paying particular attention to cords at plugs, convenience receptacles, and the point where they exit from the appliance.
- Cleaning** — The appliance should be cleaned only as recommended by the manufacturer.
- Nonuse Periods** — The power cord of the appliance should be unplugged from the outlet when left unused for a long period of time.
- Object and Liquid Entry** — Care should be taken so that objects do not fall and liquids are not spilled into the enclosure through openings.
- Damage Requiring Service** — The appliance should be serviced by qualified service personnel when:
 - The power-supply cord or the plug has been damaged; or
 - Objects have fallen, or liquid has been spilled into the appliance; or
 - The appliance has been exposed to rain; or
 - The appliance does not appear to operate normally or exhibits a marked change in performance; or
 - The appliance has been dropped, or the enclosure damaged.
- Servicing** — The user should not attempt to service the appliance beyond that described in the operating instructions. All other servicing should be referred to qualified service personnel.

Power Lines — An outdoor antenna should be located away from power lines.

Outdoor Antenna Grounding — If an outside antenna is connected to the receiver, be sure the antenna system is grounded so as to provide some protection against voltage surges and built up static charges. Section 810 of the National Electrical Code, ANSI/NFPA No. 70—1984, provides information with respect to proper grounding of the mast and supporting structure, grounding of the lead-in wire to an antenna discharge unit, size of grounding conductors, location of antenna-discharge unit, connection to grounding electrodes, and requirements for the grounding electrode. See Figure.

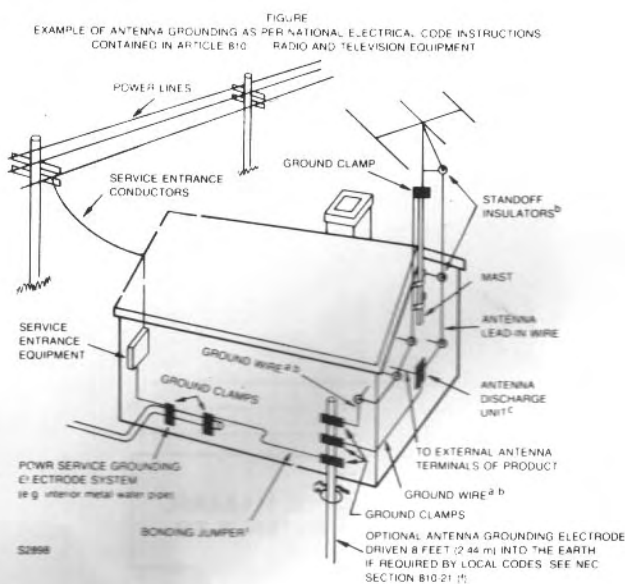

^aUse No. 10 AWG (5.3 mm²) copper, No. 8 AWG (8.4 mm²) aluminum, No. 17 AWG (1.0 mm²) copper-clad steel or bronze wire, or larger, as a ground wire.

^bSecure antenna lead-in and ground wires to house with stand-off insulators spaced from 4—6 feet (1.22—1.83 m) apart.

^cMount antenna discharge unit as close as possible to where lead-in enters house.

^dUse jumper wire not smaller than No. 6 AWG (13.3 mm²) copper, or the equivalent, when a separate antenna-grounding electrode is used. See NEC Section 810-21 (j).

FOR U.S.A. ONLY.

ENGLISH

AM/FM STEREO RECEIVER RX-845

INTRODUCTION

We at Rotel want to thank you for purchasing our audio product.

Rotel audio products are designed to use the latest electronic technology, and they incorporate our long experience as a specialist manufacturer of audio equipment. We are confident that you will find satisfaction in the high quality sound and top performance, and that you will find pleasure in the functional beauty achieved through human-engineering concept. Before starting operation, please read this instruction manual thoroughly and acquaint yourself with the proper mode of using the unit and all its connections.

We hope you will enjoy top-notch performance for many years to come.

BEFORE ENJOYMENT/ POWER SUPPLY

Follow the instructions below for maximum safety:

1. Use a wall outlet for power supply

Be sure to connect the AC line cord directly to a household wall outlet, and not to an auxiliary outlet on another component. Be certain that the outlet voltage matches the electrical rating of the unit, found on the rear panel name plate.

2. Connecting and removing AC cord

Be sure to connect or disconnect the AC line cord only after turning off the power switch to prevent possible shock noise or damage to the speakers.

3. Ventilate the unit well

Never block any ventilation holes at the top and bottom of the unit. Be sure also to provide ample ventilation space around the unit. Poor ventilation may result in damage due to excessive heat.

4. Do not open the cabinet

In order to avoid electric shock or damage to the component, never open the cabinet. If a foreign object falls inside the unit by mistake, turn the power off, disconnect the wall plug, and consult a qualified electrician or your dealer.

5. Installation

Be sure to place the unit in a level and flat place where it is free from humidity, vibration, high temperature and not exposed to direct sunlight. Be careful not to place the unit in a highly enclosed place such as near a wall or on a bookshelf. A poor ventilation will cause undesirable effects to the unit.

6. Moving the unit

When transporting, remove the AC cord from the wall outlet and all other connected cords on the rear panel to prevent wire breakage and short circuits.

7. If the unit gets wet

If the unit should get wet, immediately disconnect the AC cord, and consult your dealer or a qualified electrician.

8. Cleaning and maintenance

Do not use chemicals such as benzene or thin-

ners on the front panel. Always use a soft, dry cloth to clean the unit.

9. Owner's manual

Keep the owner's manual near the unit, and record the serial number (found on the rear panel) on the cover.

EXCLUSIVE NOTE FOR U.K.

If your unit comes with a 2-core cable without a plug, make certain live and neutral leads are connected to the proper terminals. Check that the terminals are screwed down firmly and no loose strands of wire are present.

IMPORTANT: The wires in this mains lead are coloured in accordance with the following code:

BLUE: NEUTRAL
BROWN: LIVE

As the colours of the wires in the mains lead of this apparatus may not correspond with the coloured markings identifying the terminals in your plug proceed as follows.

The wire which is coloured BLUE must be connected to the terminal which is marked with the letter N or coloured BLUE or BLACK. The wire which is coloured BROWN must be connected to the terminal which is marked with the letter L or coloured BROWN or RED.

SPEAKERS

Use speaker systems with impedance ratings of 4-16 ohms, when you hook up 2 sets of speaker systems, be sure to speakers with ratings of 8-16 ohms. Before hooking up your speaker system, check its impedance, which should be indicated either on the back of the speaker, or in the speaker instruction manual.

HOOKING UP SPEAKERS

On the rear panel of the RX845 are two sets of speaker terminals, "A" and "B", to which two speaker systems may be connected. Connect the speaker leads of the right-hand speaker to terminals "R" of "A" (or "B"), and the speaker leads of the left-hand speaker to terminals "L" of "A" (or "B"). Make sure that the "+" speaker lead is connected to the "+" terminal, and the "-" lead to the "-" terminal. Strip 1.0cm (3/8") of the polyvinyl chloride insulation from the end of each speaker lead. Twist the exposed strands tightly, and secure the end with a touch of solder. The terminals are the push-insert type. Insert the end of the lead into the hole while pushing on the button. Then release the button; the hole will close and the cord is firmly fixed.

Note: When only one pair of speakers is used, be sure to connect them to terminals "A". If they are connected to terminals "B", no sound will be produced, even when the speaker selector is set to "A + B" position.

SPEAKER/RIGHT

SPEAKER/LEFT

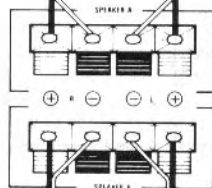
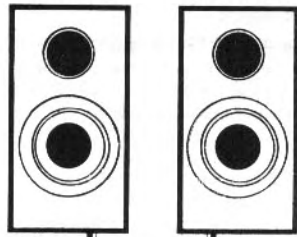

SPEAKER/RIGHT

SPEAKER/LEFT

ANTENNA INSTALLATION AND CONNECTION

■ FM Antenna

Proper installation of antenna is the key to smooth signal reception. To install the attached T-shape indoor antenna, stretch it taut and secure horizontally along a wall or the like in a location where signal reception is optimal. Securely connect the antenna to FM antenna terminals marked "300Ω" on the rear panel. If outdoor type FM antenna is installed, the T-shape antenna is not necessary. For proper use of your outdoor FM antenna, follow the instructions below.

1. Be sure to select the most appropriate type of antenna for the signal reception conditions in your area.

2. A 75-ohm coaxial cable is recommended

in connecting the antenna to the unit.

3. Set the antenna in a position as high as possible if buildings, mountains or other obstructions nearby affect reception.

4. The 75-ohm coaxial antenna cable should be properly hooked up to the designated antenna terminals on the rear panel: Locate the terminals labeled "75Ω". Connect the center conductor of the cable to the left-hand terminal, and connect the outer braided conductor of the cable to the right-hand terminal (marked "GND").

■ AM Antenna

Erect the AM ferrite bar antenna provided on the rear panel. If you install outdoor AM antenna, connect the antenna lead wire to the antenna terminal marked "AM."

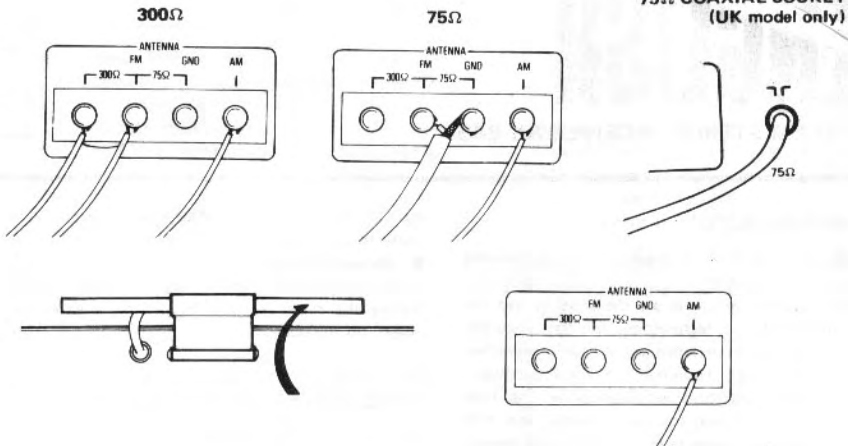

CONNECTING COMPONENTS

Connect all necessary audio components to the rear panel of the unit, using RCA pin cords. See the illustration for properly completed connections. When connecting RCA pin cords, be sure that L (left) and R (right) markings on each component are matched correctly. Connect the grounding wire of the turntable to the terminal marked GND on the receiver.

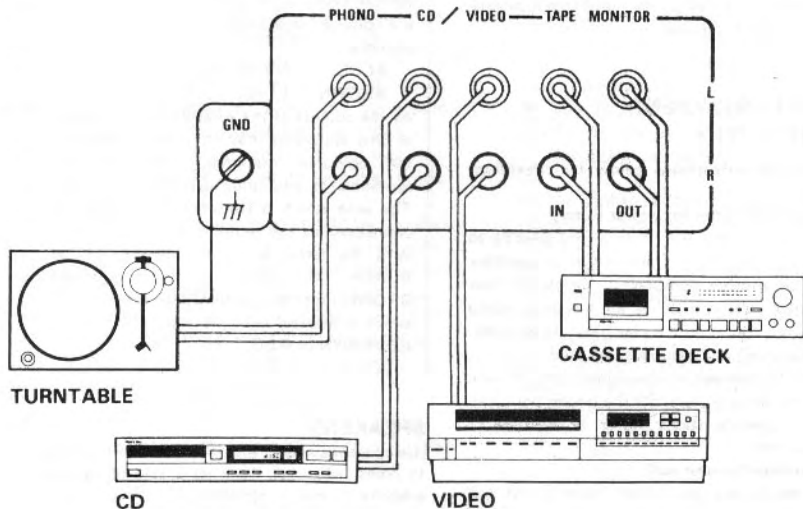

SWITCHES AND CONTROLS

(1) Power Button

This button turns on the unit. The LED indicator above it will glow when the power is on. Press the button a second time to turn off the power.

(2) Headphone Jack

Plug your headphones into this jack for private listening. When using headphones, both A and B speaker buttons should be in released (OFF) position so that sound is emitted only from the headphones. Volume level of headphone sound can be controlled with the volume control.

(3) Speaker Buttons (A, B)

By these buttons you may select speaker system you wish to use. Press button A to activate the speaker system connected to speaker terminals A on the rear panel, and button B for the system connected to speaker terminals B. Depressing both A and B buttons will activate both speaker systems. When only one speaker system is hooked up, press the corresponding button only, and release the other button of OFF. Otherwise no sound will be produced.

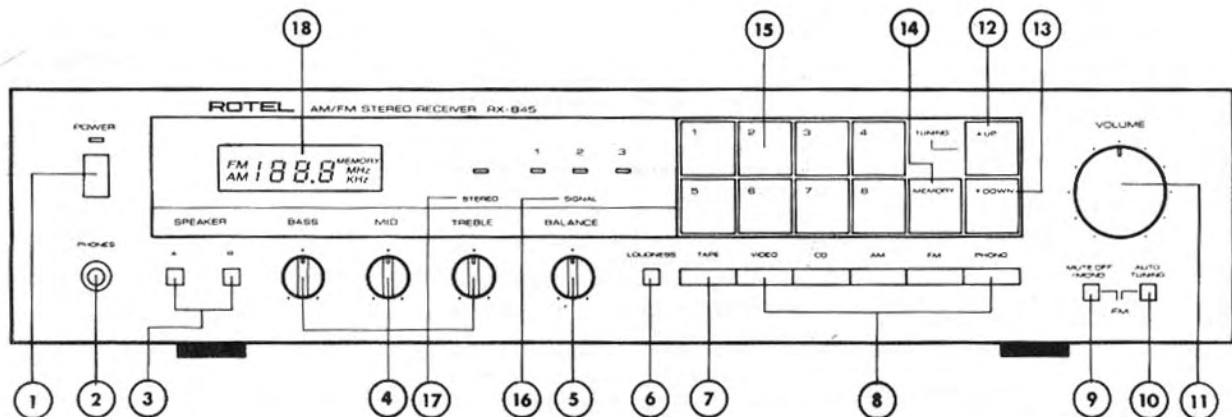

(4) Bass/Mid/Treble Tone Control

These knobs allow you to regulate frequency response in 3 separate ranges. Use them to tailor your favorite sound. The knob labeled BASS is used for low frequency range, the knob labeled MID is for middle frequency range, and the knob labeled TREBLE is high frequency range. Rotate each knob clockwise to boost the response, and counterclockwise to cut it. Achieve the sound you like best by using those controls effectively.

(5) Balance Control

In the central position, sound is produced in equal level from both speakers, while turning it to the right decreases the sound from the left speaker, and turning it to left decreases the sound from the right speaker.

(6) Loudness Button

The human ear has a tendency to become less sensitive to very low or high frequencies when listening at reduced volume levels. This button activates a compensation function that boosts those frequencies so that a more natural sound is heard.

(7) Tape Monitor Button

Depress this button when you wish to listen to the signal from tape deck. In the released position, the unit operates in the mode selected by the function selector.

(8) Function Selector

The function selector is used to select program sources you wish to listen to. Note that the selector does not work when the Tape Monitor are activated.

PHONO:

Depress when playing the turntable connected.

FM:

Depress when listening to FM broadcast.

AM:

Depress when listening to AM broadcast.

CD:

Depress when playing the connected compact disc (CD) player.

VIDEO:

Depress when playing the connected VCR (video cassette recorder).

(9) FM Mute Off/Mono Button

When this button is pressed to ON, any FM broadcast is received monaurally. Be sure to leave the button in the released (OFF) position during normal stereo FM reception. In the OFF position, interstation noise generated when tuning in an FM station will be reduced.

(10) FM Auto Tuning Button

Depress this button change FM tuning mode from manual to automatic and it will be automatic scanning of FM Band.

(11) Volume Control

This knob regulates the volume level. Rotate the knob clockwise to raise the volume level, and counterclockwise to reduce it. When the knob is turned fully counterclockwise, no sound is produced. Always have the volume control set to minimum before you turn on power.

(12) Tuning Button, UP

Used when tuning in a station whose frequency is higher than the reading on the frequency display.

(13) Tuning Button, DOWN

Used when tuning in a station whose frequency is lower than the reading on the frequency display.

(14) Memory Button

To enter a given station frequency into the unit's memory circuit, press this button first, and then tap the desired station button.

(15) Station Buttons

These buttons are used to tune in to desired preset stations, or to preset given station frequencies in unit's memory.

(16) Signal Indicator

The three LEDs show incoming signal strength; the receiving condition is optimal when all three LEDs are illuminated.

(17) Stereo Indicator

Glowes when stereo broadcasting signal is tuned in. Note that when stereo signal is very weak, the unit will not give stereo reproduction, and the indicator will not light up.

(18) Frequency Display

In the station frequency displaying "FM" and "MHz" appear in FM reception, and "MW" and "KHz" in AM reception. When press memory button then "MEMORY" will be appeared temporarily.

OPERATION

• The RX-845 is an AM/FM stereo receiver employing quartz PLL synthesizer tuning for superb operation.

By presetting the broadcasting frequency, optimum tuning will be obtained every time by simply pressing the selector button.

When the power switch is set to ON, power will be provided to the memory circuit from the AC mains. In the event of a power failure, or when the power switch is set to OFF or when the power cord is unplugged from the wall outlet, the memory circuit will be powered by the capacitor back-up. Consequently, the memory circuit will continue to function when the receiver is not being used over three days, the stored frequencies will be lost.

• Before commencing operation, check to see that all connections are properly made.

• Always be sure to set the volume control to the minimum position before turning on power.

• Select speaker button A or B (or both) for the speaker system(s) you are going to use.

• When using headphones, set both speaker buttons to released (OFF) position.

• Set tone controls and loudness button as desired.

Radio Listening

1. Set both Tape Monitor buttons in released (OFF) position.
2. Depress AM or FM button on the function selector.
3. Tune in to the desired station by means of tuning or station buttons. (See section on "Tuning".)
4. Raise the volume to the desired level.

TUNING:

The unit is designed to permit three modes of tuning: auto tuning, manual tuning, and preset memory tuning.

• Auto Tuning (for FM Reception Only)

Set FM Manual Tuning button to the released position. Press Tuning button, UP or DOWN. Automatic scanning of FM band begins. Scanning stops when it reaches a point where the input signal exceeds a certain acceptable level. The receiving frequency is held on the readout. To tune in to another station, press DOWN or UP button according to the frequency of the desired station.

• Manual Tuning

Set FM Manual Tuning button to the depressed position. A tap of the tuning button, DOWN or UP, will shift the tuning frequency in specified increments. If you keep the button pressed down, the frequency will change continuously. Release the button to stop frequency change.

• Preset Memory Tuning

Tune in to the desired station in either auto or manual tuning mode. Press the Memory Program button. The MEMORY indicator will light up. Then, press any station button, 1 through 8, to enter the frequency into the memory circuit. Thereafter, you may recall the same frequency any time simply by pressing the same button.

Note that the MEMORY indicator remains on for several seconds only; you should press the appropriate station button to enter the station frequency during that time. If the MEMORY indicator turns off before you press the station button, entry cannot be made. In that case start again, following the above procedures. The above procedures should also be followed to change the station preset for a given station button.

Note: If you have turned off the unit, and turn it on again, the unit will tune in to the station frequency to which it was tuned immediately before turn-off.

Turntable Listening

1. Set both Tape Monitor buttons in released (OFF) position.
2. Depress PHONO button on the function selector.
3. Start the play, then raise the volume.

Listening from Compact Disc Player or Video Cassette Recorder

1. Set Tape Monitor button in released (OFF) position.
2. To listen to a compact disc, press CD button on the function selector press VIDEO button to play video cassette tape.
3. Put the compact disc player or video cassette recorder in the play mode according to instructions given for the equipment.
4. Raise the volume to the desired level.

Tape Deck Playback

1. Depress either Tape Monitor button, TAPE 1 or TAPE 2, according to the tape deck you wish to use.
2. Start playback.
3. Raise the volume.

Recording Program Source

Play the desired program source according to the procedures noted above. The signal from the source will appear at TAPE MONITOR OUT terminals on the unit rear panel. Put the tape deck in the recording mode to record the signal. During recording, manipulating volume control, tone controls, etc. will have no effect on the signal being sent through the TAPE MONITOR OUT terminals.

HUM AND NOISE

In any high fidelity installation, hum may be caused by the interconnection of a turntable, tuner and amplifier, and speakers as the result of wiring, different grounding or locations of components.

If hum is experienced with your unit, disconnect everything but the speakers from the unit. Plug in the turntable and if hum or howling appears, move the turntable away from the speakers as much as possible.

Note hum may also be induced by defective cable connections or by running the cables too close to a strong AC field.

When your unit picks up noise during the reception of broadcasts, causes are mostly due to external objects such as fluorescent lamps and house appliances using motor or thermostat, or others that may induce the noise.

Either relocating the unit away from the noise sources or using an improved outdoor antenna may readily solve the problem.

In the event you cannot find the cause, consult your dealer or a qualified electrician.

VOLTAGE SELECTION

Not available for U.K., Canada and Scandinavia

The unit is a variable voltage equipment that can run on 120V, 220V or 240V power supply. Your unit should already be preset at the proper voltage for use in your area. However, if you move to an area where the power supply voltage is different, consult your dealer.

SPECIFICATIONS AMPLIFIER SECTION

Continuous Power Output.....	30 watts* per channel, min. RMS both channels driven into 8 ohms from 20 to 20,000 Hz with no more than 0.05% total harmonic distortion.
DIN Output.....	36 watts per channel (1 kHz, 4 ohms, 1% THD)
Music Power.....	118 watts total (58 w/ch)
Total Harmonic Distortion..... (20 to 20,000 Hz)	No more than 0.05% (continuous rated power output)
Intermodulation Distortion..... (60 Hz: 7 kHz = 4:1)	No more than 0.05% (continuous rated power output)
Output: Speaker.....	8-16 ohms (A + B), 4-16 ohms (A or B)
Headphone.....	4-16 ohms
Damping Factor.....	40 (20-20,000 Hz, 8 ohms)
Input Sensitivity/Impedance:	
PHONO.....	2.5mV/47 kohms
CD, VIDEO.....	400 mV/47 kohms
TAPE.....	150 mV/35 kohms
Overload Level (T.H.D. 0.5%, 1 kHz):	
PHONO.....	150mV
TAPE, CD, VIDEO.....	3V
Frequency Response:	
PHONO.....	20 to 15,000 Hz, ± 0.3 dB (RIAA STD)
TAPE CD, VIDEO.....	10 to 45,000 Hz, $+ 0.5$ dB, $- 3.0$ dB
Tone Control:	
BASS.....	± 7 dB, 100 Hz
MID.....	± 7 dB, 1 kHz
TREBLE.....	± 7 dB, 10 kHz
Loudness Contour.....	$+ 7$ dB (100 Hz), $+ 4$ dB (10 kHz)
(volume control set at -40 dB position)	
Signal-to-Noise Ratio (IHF, A network):	
PHONO.....	80 dB
TAPE, CD, VIDEO.....	90 dB

FM TUNER SECTION

Usable Sensitivity (mono).....	10.8 dBf/1.9 μ V
DIN Sensitivity (26 dB S/N, 75 ohms).....	1.5 μ V
50 dB Quieting Sensitivity:	
Mono.....	17.2 dBf/4 μ V
Stereo.....	40.7 dBf/60 μ V
Signal-to-Noise Ratio (at 65 dBf):	
Mono.....	72 dB
Stereo.....	65 dB
Harmonic Distortion (at 65 dBf):	
100 Hz.....	0.15% (mono), 0.4% (stereo)
1 kHz.....	0.15% (mono), 0.4% (stereo)
6 kHz.....	0.2% (mono), 0.5% (stereo)
Frequency Response.....	20 to 14,000 Hz, $+ 0.3$ dB, $- 3$ dB
Caputer Ratio.....	1.5 dB
Alternate Channel Selectivity (± 400 kHz).....	60 dB
Spurious Response Ratio.....	75 dB
Image Response Ratio.....	45 dB
IF Response Ratio.....	85 dB
AM Suppression Ratio.....	58 dB
Stereo Separation.....	100 Hz/1 kHz/10 kHz, 38 dB/43 dB/33 dB
Subcarrier Product Ratio.....	40 dB

AM TUNER SECTION

Sensitivity.....	250 μ V/m
Selectivity.....	35 dB
Signal-to-Noise Ratio.....	50 dB
Image Response Ratio.....	45 dB
IF Response Ratio.....	38 dB
MISCELLANEOUS	
Power Requirement.....	120V/60 Hz, 220V/50 Hz, 240V/50 Hz, or 120, 220, 240V/50-60 Hz (depending on destinations)
Power Consumption.....	180 watts
Dimensions (Overall).....	430 (W) x 94 (H) x 332 (D) mm 16-15/16" x 3-11/16" x 13-1/16"
Weight (net).....	7.3 kg/16.06 lbs.

- Specifications and design subject to possible modification without notice.
- *Measured pursuant to the Federal Trade Commission's Trade Regulation Rule on Power Claims for Amplifiers (applicable to the U.S.A. only).