

# ROTEL *hiFi*

## RT-990BX

### STEREO FM TUNER



# OWNER'S MANUAL

**WARNING:**  
TO PREVENT FIRE OR SHOCK HAZARD,  
DO NOT EXPOSE THIS APPLIANCE TO  
RAIN OR MOISTURE.

Write your SERIAL NUMBER here.  
The number is located near the  
name plate on the rear panel.

# SAFETY INSTRUCTIONS

1. **Read Instructions** — All the safety and operating instructions should be read before the appliance is operated.
2. **Retain Instructions** — The safety and operating instructions should be retained for future reference.
3. **Heed Warnings** — All warnings on the appliance and in the operating instructions should be adhered to.
4. **Follow Instructions** — All operating and use instructions should be followed.
5. **Water and Moisture** — The appliance should not be used near water — for example, near a bathtub, washbowl, kitchen sink, laundry tub, in a wet basement, or near a swimming pool, and the like.
6. **Carts and Stands** — The appliance should be used only with a cart or stand that is recommended by the manufacturer.
  - 6A. An appliance and cart combination should be moved with care. Quick stops, excessive force, and uneven surfaces may cause the appliance and cart combination to overturn.
7. **Wall or Ceiling Mounting** — The appliance should be mounted to a wall or ceiling only as recommended by the manufacturer.
8. **Ventilation** — The appliance should be situated so that its location or position does not interfere with its proper ventilation. For example, the appliance should not be situated on a bed, sofa, rug, or similar surface that may block the ventilation openings; or placed in a built-in installation such as a bookcase or cabinet that may impede the flow of air through the ventilation openings.
9. **Heat** — The appliance should be situated away from heat sources such as radiators, heat registers, stoves, or other appliances (including amplifiers) that produce heat.
10. **Power Sources** — The appliance should be connected to a power supply only of the type described in the operating instructions or as marked on the appliance.
11. **Grounding or Polarization** — The precautions that should be taken so that the grounding or polarization means of an appliance is not defeated.
12. **Power-Cord Protection** — Power-supply cords should be routed so that they are not likely to be walked on or pinched by items placed upon or against them, paying particular attention to cords at plugs, convenience receptacles, and the point where they exit from the appliance.

## PORTABLE CART WARNING



S3125A

13. **Cleaning** — The appliance should be cleaned only as recommended by the manufacturer.
14. **Nonuse Periods** — The power cord of the appliance should be unplugged from the outlet when left unused for a long period of time.
15. **Object and Liquid Entry** — Care should be taken so that objects do not fall and liquids are not spilled into the enclosure through openings.
16. **Damage Requiring Service** — The appliance should be serviced by qualified factory authorized service personnel when:
  - A. The power-supply cord or the plug has been damaged; or
  - B. Objects have fallen, or liquid has been spilled into the appliance; or
  - C. The appliance has been exposed to rain; or
  - D. The appliance does not appear to operate normally or exhibits a marked change in performance; or
  - E. The appliance has been dropped, or the enclosure damaged.
17. **Servicing** — The user should not attempt to service the appliance beyond that described in the operating instructions. All other servicing should be referred to qualified factory authorized service personnel.

**WARNING: To reduce the risk of fire or electric shock, do not expose this appliance to rain or moisture**

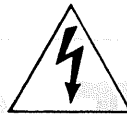

**CAUTION**  
RISK OF ELECTRIC SHOCK  
DO NOT OPEN



**CAUTION: TO REDUCE THE RISK OF ELECTRIC SHOCK, DO NOT REMOVE COVER (OR BACK). NO USER-SERVICEABLE PARTS INSIDE. REFER SERVICING TO QUALIFIED SERVICE PERSONNEL.**

### • Explanation of Graphical Symbols

The lightning flash with arrowhead symbol, within an equilateral triangle, is intended to alert the user to the presence of uninsulated "dangerous voltage" within the product's enclosure that may be of sufficient magnitude to constitute a risk of electric shock to persons.



The exclamation point within an equilateral triangle is intended to alert the user to the presence of important operating and maintenance (servicing) instructions in the literature accompanying the appliance.



**Power Lines** — An outdoor antenna should be located away from power lines.

**Outdoor Antenna Grounding** — If an outside antenna is connected to the receiver, be sure the antenna system is grounded so as to provide some protection against voltage surges and built up static charges. Section 810 of the National Electrical Code, ANSI/NFPA No. 70—1984, provides information with respect to proper grounding of the mast and supporting structure, grounding of the lead-in wire to an antenna discharge unit, size of grounding conductors, location of antenna-discharge unit, connection to grounding electrodes, and requirements from the grounding electrode. See Figure.

- a - Use No. 10 AWG (5.3 mm<sup>2</sup>) copper, No. 8 AWG (8.4 mm<sup>2</sup>) aluminum, No. 17 AWG (1.0 mm<sup>2</sup>) copper-clad steel or bronze wire, of larger, as a ground wire.
- b - Secure antenna lead-in and ground wires to house with stand-off insulators spaced from 4—6 feet (1.22 — 1.83 m) apart.
- c - Mount antenna discharge unit as close as possible to where lead-in enters house.
- d - Use jumper wire not smaller than No. 6 AWG (13.3 mm<sup>2</sup>) copper, or the equivalent, when a separate antenna-grounding electrode is used.

### EXAMPLE OF ANTENNA GROUNDING AS PER NATIONAL ELECTRICAL CODE INSTRUCTIONS

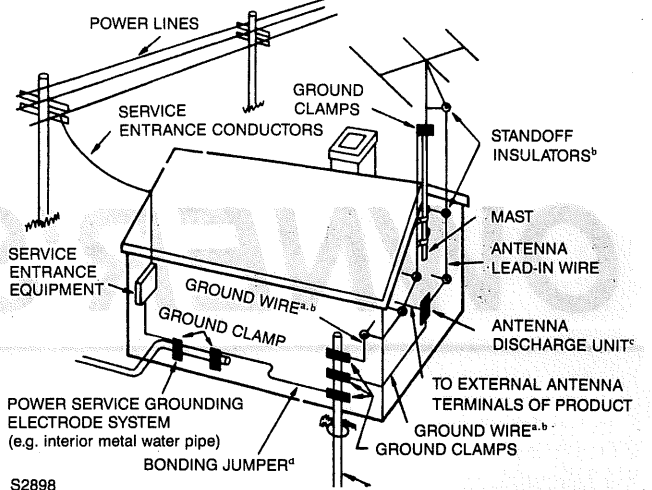

OPTIONAL ANTENNA GROUNDING ELECTRODE DRIVEN 8 FEET (2.44 m) INTO THE EARTH IF REQUIRED BY LOCAL CODES. SEE NEC SECTION 810-21 (f)

FOR U.S.A. ONLY

## INTRODUCTION

### A WORD FROM ROTEL

We at Rotel take this opportunity to thank you for choosing our RT-990BX Tuner. Our commitment and dedication to the design and manufacturing of high fidelity products for more than thirty years has guided our creation of equipment with the highest level in sound reproduction. We are confident that you will enjoy this Rotel tuner, now and for many years to come.

Please read this instruction manual thoroughly before you start using your tuner and keep it in a safe place for future reference. Please keep the box in case the unit should need service or if you move. Thank you for purchasing the RT-990BX tuner.

### INTRODUCING THE RT-990BX TUNER

The Rotel RT-990BX is a FM only tuner designed for audiophiles who require few functions, but insist on the purest sound.

The circuitry employs a highly sophisticated grounding technique to achieve a very low noise floor and improved selectivity. The entire tuner circuitry is built on a main board to ensure common grounding between all sections, except the power supply and front panel control sections, which are placed on separate boards to prevent hum and noise interference.

All components are specially selected for their sound performance, longevity and close tolerances, and are dimensioned to withstand wide temperature variations without deviation. Custom-made components, such as the transformer and stereo decoder, provide optimum performance.

The entire high frequency tuner section is shielded in a copper enclosure to eliminate any possible interference with other circuits. The audio outputs are buffered by high speed operational amplifiers, providing a low-impedance high-current output, capable of driving any possible combination of interconnects and amplifiers.

The power switch incorporates a standby function, similar to the "off" state of conventional equipment, but it ensures that the tuner's internal circuitry remains at a constant operating temperature. This provides the best possible sound at any time without the need to wait until the unit is warmed-up after turning the power on.

Automatic tuning is incorporated to ease selection of broadcast stations, and sixteen presets are provided to store your preferred stations for effortless recall. Other features include: automatic muting of weak stations, a mono/stereo selector, an RF attenuator, a wide bandwidth selector, and a comprehensive display showing the preset number, receiving frequency and signal strength. Display and control functions are minimized to prevent any adverse effects on the received signal.

A remote control is included providing control of all basic functions as well as controlling the basic functions of our RC-990BX control amplifier.

## UNPACKING AND INSTALLING

### CONTENTS OF PACKAGING BOX

- RT-990BX tuner
- RR-909 remote control unit and batteries
- Stereo interconnecting cable and indoor-antenna wire
- 300 ohm to 75 ohm adapter (North America only)
- Instruction manual

If any of these items is missing, please contact your dealer immediately.

### UNPACKING & LOCATION

Carefully unpack your tuner. We advise you to keep the packaging material for future use in case you move or need to return the unit for servicing. Please ensure that you place the unit on a flat surface where it will be free from excessive humidity, vibration, high temperatures and direct sunlight.

### INTERFERENCE

Certain equipment, such as computers, may cause reception interference to your tuner. One or a combination of the following measures may be required to eliminate this interference:

- Reorient or relocate the indoor-antenna, or use an outdoor-antenna instead.
- Increase the distance between the tuner and the interfering apparatus.
- Connect the tuner into a mains outlet on a circuit different to that which the interfering apparatus is connected. Contact your dealer for further advice.

## ELECTRICAL REQUIREMENTS

Your equipment has been designed to be powered by your local AC (mains) supply. Before connecting it to the AC outlet, check the voltage rating at the name plate found on the rear panel. Never plug the unit into an outlet of voltage different to that specified. The wrong voltage can cause a serious fire hazard. Consult your dealer if in doubt.

**EXCLUSIVE NOTE FOR U.K.**-If your unit comes with a 2-core mains lead without a plug, neither core is to be connected to the earth terminal of a three pin plug, make certain they are connected according to the following instruction, to the proper terminals. Check that the terminals are screwed down firmly and no loose strands of wire are present. **IMPORTANT:** The wires in the mains lead are coloured in accordance with the following code:

BLUE = NEUTRAL / BROWN = LIVE

As the colours of the wires in the mains lead of this apparatus may not correspond with the coloured markings identifying the terminals in your plug, proceed as follows: The wire which is coloured BLUE must be connected to the terminal which is marked with the letter N or coloured BLUE or BLACK. The wire which is coloured BROWN must be connected to the terminal which is marked with the letter L or coloured BROWN or RED.

## THE CABINET

There are no user-serviceable parts inside the unit. Do not attempt to open the cabinet, as this could damage your unit and void your warranty. If the tuner is dropped, damaged or does not seem to function properly, disconnect the power cord immediately and consult your dealer. If your unit becomes dirty, wipe it gently with a soft, dry cloth. Never use solvents of any kind.

## REMOTE CONTROL UNIT

Remove the battery cover - on the back of the remote control unit -, and insert two batteries in the correct position, as indicated. Close the cover, to secure the batteries properly. To ensure the proper functioning and safe-keeping of the remote control unit:

- Keep remote control unit away from extremely hot or humid places;
- Avoid dropping and spilling liquids on or into the remote control unit;
- Avoid exposing the remote sensor to direct sunlight or lighting apparatus.
- Remove the batteries when the remote control unit will not be used for a long time, to avoid leakage of the batteries that could damage your remote control unit.

**NOTE:** The average lifetime of the batteries is approximately one year, but may vary depending on the intensity of use. When the tuner no longer responds to remote commands, the batteries should be replaced.

## MAKING THE CONNECTIONS

See Illustration - Rear Panel, to visualize where the connections should be made

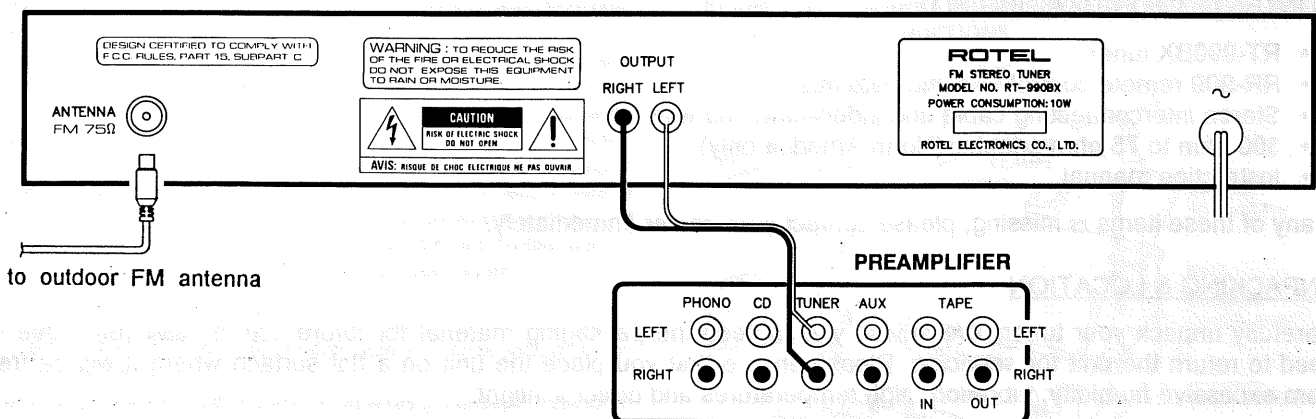

### 1. CONNECTING TO AN INTEGRATED AMPLIFIER OR PREAMPLIFIER

Ensure that your tuner and amplifier are switched off before you connect them. Connect the OUTPUT jacks on the back of the tuner, to the tuner INPUT jacks of your amplifier, using the interconnect cord supplied with your tuner. Make sure the right (RED) and the left (WHITE) jacks are correctly connected to the corresponding inputs on your amplifier. You may also connect the tuner to the AUX input jacks on your amplifier if the tuner input is already being used by another tuner, or if there is no tuner input available.

## 2. CONNECTING THE ANTENNA

**Indoor FM Antenna** - the supplied indoor antenna is sufficient for the reception of broadcast stations in good reception areas. To install it, connect the antenna wire to (the adapter that converts 300 ohm to 75 ohm, and push this on - N. America only) the antenna INPUT terminal on the back of the tuner. Then stretch the wire out and secure it along the wall. Repositioning the antenna may improve reception quality.

### • Applicable for U.S.A., Canada version

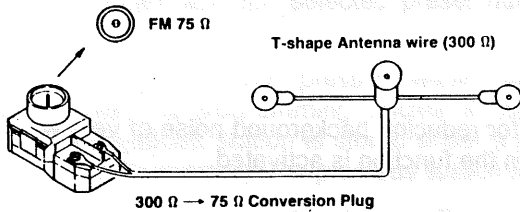

### • Applicable for European version

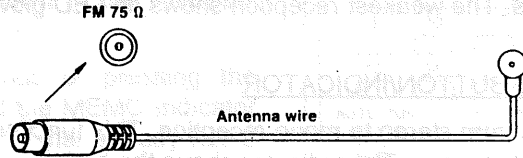

**Outdoor FM Antenna** - In areas of average to weak reception conditions, an outdoor-antenna, mounted on the rooftop, may be required for best results. To install it, connect the antenna plug to the antenna INPUT terminal on the back of the tuner. While we feel that an indoor antenna will give adequate reception, only an outdoor antenna will truly let the tuner perform to its potential.

## 3. CONNECTING THE POWER CORD

Always handle the power cord with care and never pull the plug out by tugging the cord. Connect the power cord to the mains outlet. The tuner will automatically go into STANDBY mode when connected to a mains outlet.

**NOTE:** Verify that all connections are properly made and that the tuner and amplifier have been plugged in. Hum and noise may be caused either by improper connection between tuner, amplifier and/ or speakers, or as a result of different grounding or location of the components. Check that the audio interconnect cables are completely inserted into their sockets on both tuner and amplifier.

## LOCATION AND OPERATION OF CONTROLS - Front Panel

See Illustration - Front Panel, to visualize the location of the front panel controls.

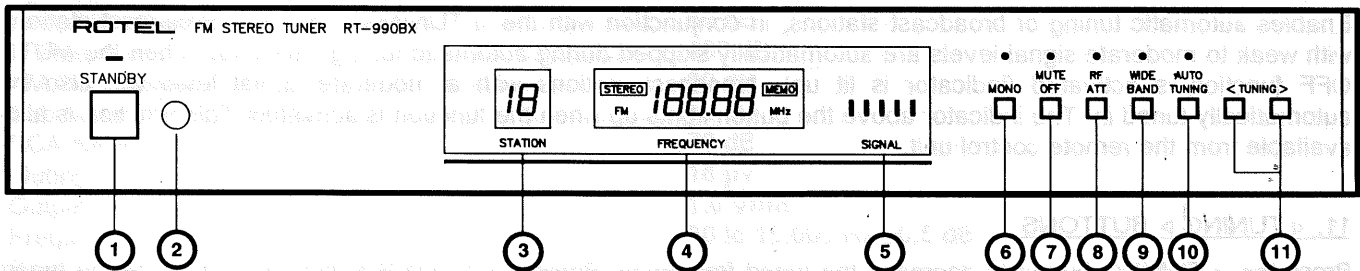

### 1. STANDBY BUTTON/INDICATOR

Press this button to turn the tuner on, and press it again back to Standby mode. the Standby indicator will glow constantly. The tuner is always at STANDBY mode while AC power is connected. When the tuner is switched from standby to on, all the buttons and functions that had been activated when the tuner was switched to standby, will remain activated. The Standby button is also available from the remote control unit.

### 2. REMOTE CONTROL SENSOR

Receives the control commands from the remote control unit. The remote control unit should be aimed toward the sensor - in as straight a line as possible -, in order for the remote functions to be acknowledged.

### 3. PRESET DISPLAY

Indicates the selected preset. Until the presets are programmed however, the preset numbers do not appear on the display. The programming of the presets will thus enable you to store the desired frequencies and to see the presets on the display. There are 16 different presets available on the remote control unit.

#### **4. FREQUENCY DISPLAY**

Indicates the received frequency; shows the word STEREO when a stereo broadcast station is received; and shows the word MEMO during programming of presets.

#### **5. SIGNAL DISPLAY**

Indicates the signal strength of the received broadcast station. The strongest reception is indicated by lighting all five LEDs. The weakest reception shows no LED glowing.

#### **6. MONO BUTTON/INDICATOR**

Switches from stereo to mono reception. This function is useful for reducing background noise of very weak stereo broadcast stations. The indicator above the button lights up when the function is activated.

#### **7. MUTE OFF BUTTON/INDICATOR**

Switches the automatic mute function off, enabling the reception of weak stations. The indicator above the button lights up when the function is activated. When the muting is on, weak stations cannot be heard. When you deactivate the muting (i.e. MUTE OFF indicator lights up), weak stations may be received in mono.

#### **8. RF ATTENUATE BUTTON/INDICATOR**

Reduces sound distortion when receiving very strong broadcast stations, by attenuating the incoming antenna signal. This function is also useful for eliminating interference that may occur when a broadcast station has a moderate signal level and is adjacent to a station that has a very strong signal level. The indicator above the button lights up when the function is activated.

#### **9. WIDE BAND BUTTON/INDICATOR**

Enables reception of broadcast stations at their full broadcast bandwidth. By deactivating the wide function, interference is eliminated from broadcast stations that are too close to each other, by switching to a narrower audio bandwidth. The indicator above the button lights up when the function is activated.

#### **10. AUTO TUNING BUTTON/INDICATOR**

Enables automatic tuning of broadcast stations, in conjunction with the < TUNING > buttons. Broadcast stations with weak to moderate signal levels are automatically skipped during automatic tuning. However, when the MUTE OFF function is activated (indicator is lit up), broadcast stations with a moderate signal level will also be automatically tuned in. The indicator above the button lights up when the function is activated. This function is also available from the remote control unit.

#### **11. < TUNING > BUTTONS**

Press the < TUNING button to decrease the tuned frequency. Press the TUNING > button to increase the tuned frequency. The TUNING buttons are also available from the remote control unit.

When auto tuning is not activated, manual tuning is enabled. Pressing the TUNING buttons briefly will increase or decrease the frequency in a single step. Pressing the TUNING buttons continuously will increase or decrease the frequency until the button is released, or until the band limit is reached.

When auto tuning is activated, tuning into a broadcast station is done automatically. The tuner searches continuously until a broadcast station is received. When the end of the band is reached, tuning automatically continues in the opposite direction. To search for the next station, press one of the TUNING buttons again.

### **LOCATION AND OPERATION OF CONTROLS - Remote Control Unit**

*See Illustration - Remote Control Unit, to visualize the location of the remote controls.*

The remote control unit duplicates the standby, auto tuning and tuning buttons, from the front panel section. Please refer to the corresponding front panel for information on their use.

This remote control unit operates the RT-990BX tuner, as well as the power, volume and muting functions of the RC-990BX control amplifier, when used together.



**PRESET buttons:** There are 16 preset buttons that can be programmed to memorize broadcast stations. Press one of the preset buttons for immediate recall of a stored broadcast station.

**MEMORY button:** Allows storage of a broadcast station frequency under one of the 16 preset buttons. To program one of the preset numbers, first tune into the desired frequency, and then press the MEMORY button. The MEMO indicator in the tuner display lights up. Press the chosen PRESET button. The MEMO indicator disappears and the selected preset number is shown in the PRESET display.

If a PRESET button is not pressed within twelve seconds of pressing the MEMORY button, the programming function is canceled and the MEMO indicator goes off. If a broadcast station is stored under a preset button that already has a station stored in its memory, the previous station is replaced by the new station.

The stored presets are retained as long as the tuner is connected to mains power, regardless of whether the tuner is switched on or is in standby mode. If the power cord is disconnected or if a power interruption occurs, the stored presets are retained for at least one week.

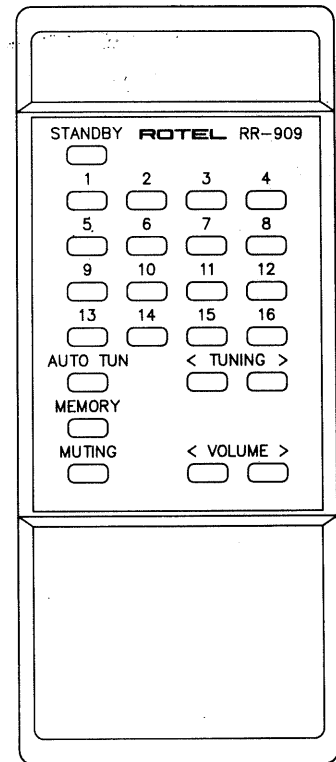

## SPECIFICATIONS

|                                    |   |
|------------------------------------|---|
| Frequency Range .....              | 87.5 to 108 MHz   |
| Antenna Input Impedance .....      | 75 ohms unbalanced  |
| Usable Sensitivity:                |   |
| Mono .....                         | 10.8 dBf (0.95 $\mu$ V) at 75 ohms                                      |
| 50 dB Quieting Sensitivity:        |   |
| Mono .....                         | 14.8 dBf (1.5 $\mu$ V) at 75 ohms                                       |
| Stereo .....                       | 37.2 dBf (20 $\mu$ V) at 75 ohms  |
| Capture Ratio .....                | 1.0 dB  |
| Alternate Channel Selectivity:     |   |
| Wide .....                         | 50 dB   |
| Narrow .....                       | 80 dB   |
| Adjacent Channel Selectivity ..... | 15 dB (Narrow)  |
| Spurious Response Ratio .....      | 100 dB  |
| Image Response Ratio .....         | 80 dB   |
| IF Response Ratio .....            | 100 dB  |
| AM Suppression Ratio .....         | 60 dB   |
| Sub carrier Product Ratio .....    | 60 dB   |
| SCA Rejection Ratio .....          | 70 dB   |
| Muting Threshold .....             | 18 $\mu$ V  |
| Output Level .....                 | 1.0 Vrms  |
| Frequency Response .....           | 30 to 15,000 Hz $\pm$ 0.5 dB  |
| Signal to Noise Ratio (at 65 dBf): |   |
| Mono .....                         | 87 dB   |
| Stereo .....                       | 82 dB   |
| Harmonic Distortion (at 65 dBf):   |   |
| Mono .....                         | 0.05 % at 1 kHz   |
| Stereo .....                       | 0.12 % at 1 kHz   |
| Stereo Separation:                 |   |
| 100 Hz .....                       | 45 dB   |
| 1 kHz .....                        | 50 dB   |
| 10 kHz .....                       | 40 dB   |
| De-emphasis .....                  | 50 $\mu$ S (Europe), 75 $\mu$ S (America)                               |
| Power Requirement .....            | 120 V/ 60 Hz, 220-240 V/ 50 Hz<br>(depending on destination)            |
| Power Consumption .....            | 12 W  |
| Overall Dimensions .....           | 440 (w) x 72 (h) x 318 (d) mm<br>17-3/8" (w) x 2-7/8" (h) X 12-1/2" (d) |
| Net Weight .....                   | 5.0 kg / 11.0 lbs   |

NOTE: Specification and design are subject to possible modification without notice.

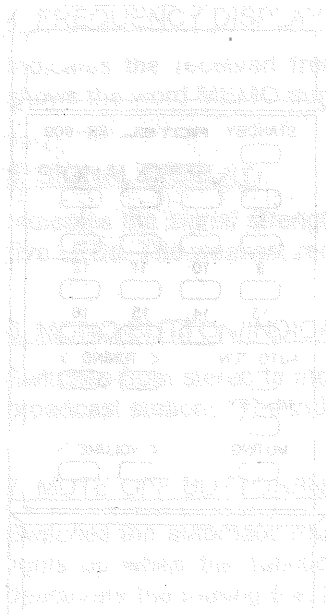

PRESET button: Pressing this button will set the programmed frequency to the preset button for immediate recall. The MEMORY button allows storage of a broadcast station frequency under one of the 18 preset buttons. To program one of the preset buttons, first tune into the desired frequency, and then press the MEMORY button. The MEMO indicator lights up, and the selected broadcast station frequency is stored in the MEMORY button. Pressing the PRESET button again will recall the selected broadcast station stored in the memory. The preset station is recalled by the new station indicator, disappears and the selected preset number is shown on the display.

If a PRESET button is not pressed within twelve seconds of pressing the MEMORY button, the programmed function is canceled and the MEMO indicator goes off. If a broadcast station is stored under the MEMORY button, the station stored in the memory. The preset station is recalled by the new station indicator. The preset station is retained as long as the unit is connected to mains power, regardless of whether the tuner is switched on or is in standby mode. If the power is cut, the preset station is lost. The preset station is recalled by the new station indicator. The preset station is retained as long as the unit is connected to mains power, regardless of whether the tuner is switched on or is in standby mode. If the power is cut, the preset station is lost. The preset station is recalled by the new station indicator.

## SPECIFICATIONS

|                            |                                     |
|----------------------------|-------------------------------------|
| Frequency Range            | 530 kHz - 1600 kHz                  |
| Bandwidth                  | 10 kHz                              |
| Modulation                 | AM, FM                              |
| Power Output               | 10 W                                |
| Frequency Response         | 50 Hz - 20 kHz                      |
| Channel Selectivity        | ± 1.5 dB                            |
| Spurious Response Ratio    | ≥ 40 dB                             |
| Intermodulation Distortion | ≥ 30 dB                             |
| Dynamic Range              | ≥ 100 dB                            |
| Signal-to-Noise Ratio      | ≥ 40 dB                             |
| THD                        | ≤ 1%                                |
| Output Level               | 10 Vrms                             |
| Power Consumption          | 15 W                                |
| Dimensions                 | 150 mm (W) x 100 mm (H) x 50 mm (D) |
| Weight                     | 1.5 kg                              |

**NOTE:** Specification and design are subject to possible modification without notice.

**Power Requirement:** 15 W

**Power Consumption:** 15 W

**Operating Conditions:** 10 Hz - 20 kHz

**Location and Operation of Controls:** See the user manual for details.