

owner's manual



Quality. Uncompromised.

ROTEL[®]

RR-700

REMOTE CONTROL CENTER

ENGLISH 5

WARNING
TO PREVENT FIRE OR SHOCK HAZARD,
DO NOT EXPOSE THIS APPLIANCE TO
RAIN OR MOISTURE

Write your SERIAL NUMBER here.

The number is located near the name
plate on the rear panel.



ENGLISH

REMOTE CONTROL CENTER RR-700

INTRODUCTION

We at Rotel want to thank you for purchasing our audio product.

Rotel audio products are designed to use the latest electronic technology, and they incorporate our long experience as a specialist manufacturer of audio equipment. We are confident that you will find satisfaction in the high quality sound and top performance, and that you will find pleasure in the functional beauty achieved through human-engineering concept. Before starting operation, please read this instruction manual thoroughly and acquaint yourself with the proper mode of using the unit and all its connections.

We hope you will enjoy top-notch performance for many years to come.

INSTALLATION

Be sure to place the unit in a level and flat place where it is free from humidity, vibration, high temperature and not exposed to direct sunlight. Be careful not to place the unit in a highly enclosed place such as near a wall or on a bookshelf. A poor ventilation will cause undesirable effects to the unit.

POWER SUPPLY

Before plugging the main unit of the RR-700 into a wall outlet, make sure its voltage rating which appears on the rear panel matches the voltage of the power source. Never attempt to connect the unit to a power source with voltage other than specified.

Power for components to be run under remote control with the RR-700 transmitter unit, which include turntable, tuner (or receiver), tape deck, and amplifier (or receiver), is supplied through the a.c. outlets on the rear panel of the main unit*. Never attempt to use those outlets to connect any electric or electronic equipment other than those items mentioned above. Do not apply power without first making sure the proper connection are completed.

If you live in U.K. and your unit comes with 2-core code without a plug, be sure to read the exclusive caution for U.K.

*The RR-700 can supply power to the following components simultaneously: Rotel stereo integrated amplifier RA-700 and AM/FM tuner RT-700 (or RT-700L) — or AM/FM stereo receiver RX-700 (or RX-700L) — stereo player RP-700 and stereo cassette deck RD-700.

EXCLUSIVE NOTE FOR U.K.

If your unit comes with a 2-core cable without a plug, make certain live and neutral leads are connected to the proper terminals. Check that the terminals are screwed down firmly and no loose strands of wire are present.

IMPORTANT: The wires in this mains lead

POWER SUPPLY CONNECTION/COMPONENT CONNECTION

(1) When using RA-700 (integrated amplifier)

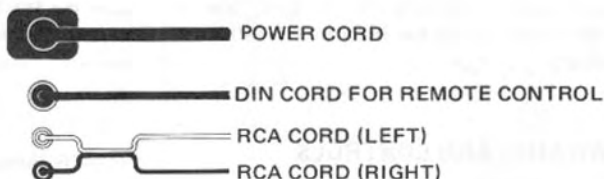
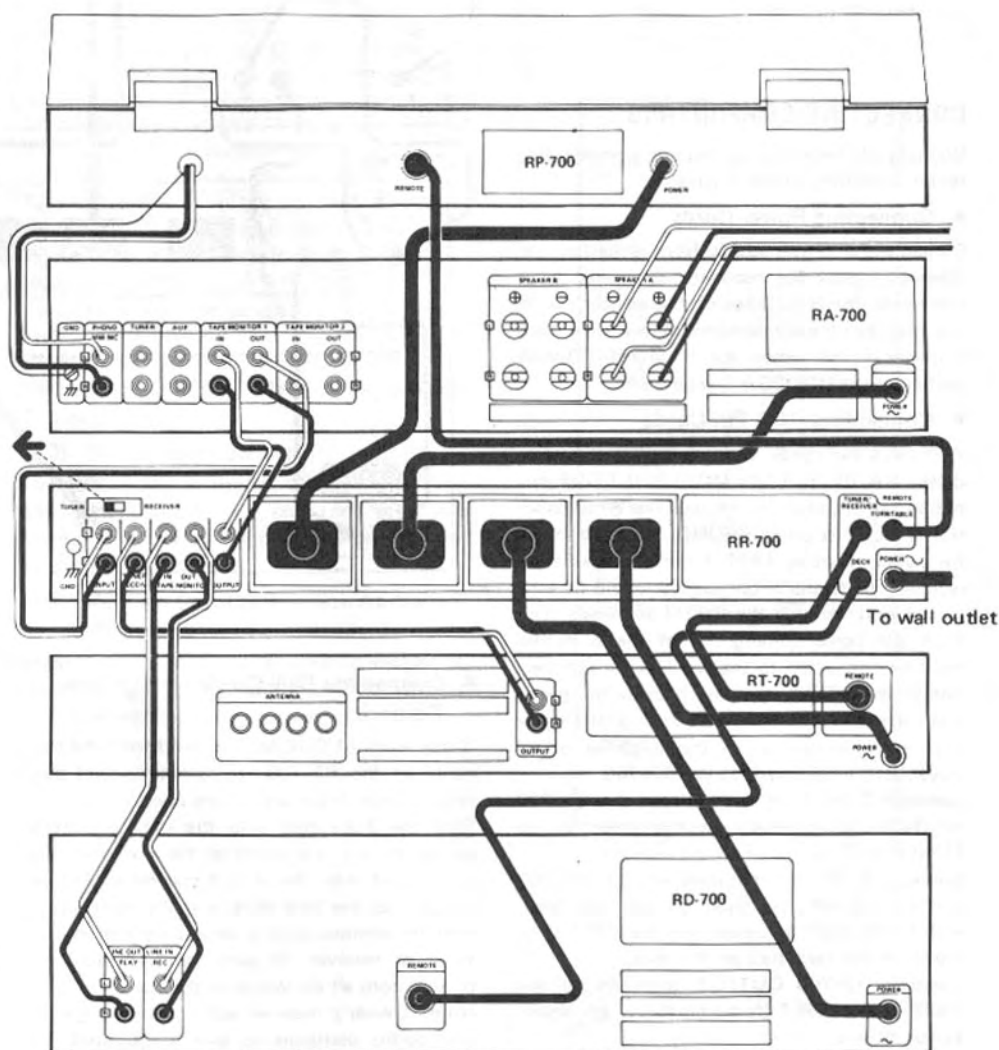

are coloured in accordance with the following code:

BLUE: NEUTRAL
BROWN: LIVE

As the colours of the wires in the mains lead of this apparatus may not correspond with the coloured markings identifying the terminals in your plug proceed as follows. The wire which is coloured BLUE must be connected to the terminal which is marked with the letter N or coloured BLUE or BLACK. The wire which is coloured BROWN must be connected to the terminal which is marked with the letter L or coloured BROWN or RED.

CONNECTING COMPONENTS

Connect all necessary audio components correctly, according to the illustration.

• Connecting Power Cords

Connect the power cords from amplifier (or receiver), tuner (or receiver), deck and turntable with the RR-700 using the a.c. outlets on the rear panel; each component will then have a power supply when the REMOTE POWER switch on the RR-700 is turned on.

• Connecting RCA Pin Cords

With RCA pin cords, connect INPUT terminals of the RR-700 to TAPE MONITOR-1 OUT terminals on the amplifier or receiver. When function selector is set to PHONO, and tape monitor switch is set to TAPE 1 on the amplifier or receiver, the signal from turntable will be sent to the unit through the INPUT terminals. The RCA pin cords coming out of the turntable must be connected to the amplifier or receiver, not to the RR-700 directly, because the signal from the turntable must pass through the equalizer amplifier section in the amplifier or receiver before being sent to the RR-700.

Connect TUNER IN terminals on the RR-700 to OUTPUT terminals on the tuner, or to TUNER OUT terminals on the receiver.

Connect TAPE IN terminals on the RR-700 to OUT (PLAY) terminals on the tape deck, and TAPE OUT terminals on the RR-700 to the IN (REC) terminals on the deck.

Connect RR-700 OUTPUT terminals to the TAPE MONITOR-1 IN terminals on the amplifier or receiver.

When connecting components with RCA pin cords, be sure to make correct left and right connections, observing the L (left) and R (right) markings on the rear panel of each component.

SWITCHES AND CONTROLS

(1) REMOTE POWER Switch

Press this button to turn on the amplifier, tuner (or receiver), tape deck, or turntable. Press the button a second time to turn off. The RR-700 main unit receives a constant supply of power as long as the unit's power cord is connected to a wall outlet.

(2) Target Eye

Receives operating commands in the form of infrared beams emitted from the remote transmitter unit.

(3) Function Selector

Used to select program sources: Press TAPE button to hear signal from the tape deck;

(2) When using RX-700 (receiver)

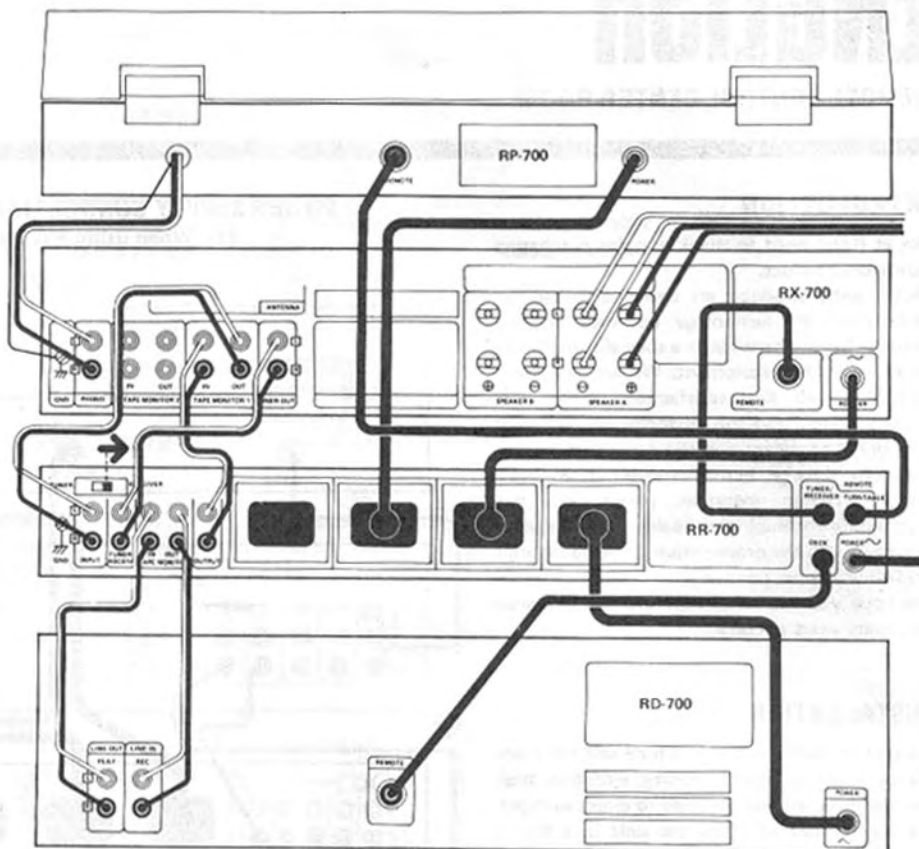

• Connecting DIN Cords For Remote Control

Three kinds of DIN cords extend from the rear panel of the RR-700 for remote-control purpose — 3-pin, 8-pin and 10-pin ones.

Plug the 3-pin cord into the remote control socket on the rear panel of the turntable; the 8-pin cord into the remote-control socket on the rear of the tape deck; and the 10-pin cord into the remote-control socket on the rear of tuner or receiver. Be sure to insert pin plug of each cord all the way into the socket.

Note: Owner's manuals accompanying respective audio components give instructions for usage under normal circumstances only. When operating those components in conjunction with the RR-700, follow the instructions given in this booklet first, for making connections and use of the equipment.

• Tuner/Receiver Selector

The rear panel of the RR-700 is provided with a slide switch for tuner/receiver changeover. This switch should be preset properly when connecting components. Set to TUNER when using the tuner RT-700 (or RT-700L), or to RECEIVER when using the receiver RX-700 (or RX-700L).

TUNER button for signal from tuner or tuner section in receiver; and PHONO button for signal from turntable. LED indicators above each button show which function is selected. The above controls can also be carried out by means of the remote transmitter.

(4) Audio Muting Button

Pressing this button will immediately cause a large reduction in volume level of the sound, and pressing it a second time will restore the previous volume. This button is most useful when you wish a temporary period of quieter sound. When the audio muting is in operation, the LED indicator above the button glows.

The above control can also be carried out by means of the remote transmitter.

(5) Volume Control DOWN (<)

This button is used to reduce the volume level of the sound. The volume decreases gradually when the button is kept pressed. The above control can also be carried out by means of the remote transmitter.

(6) Volume Control UP (>)

Used to raise the volume level of the sound. The volume increases gradually when the button is kept pressed. The maximum controllable volume level is determined by the preset position of the volume control knob on the amplifier or the receiver.

The above control can also be carried out by means of the remote transmitter.

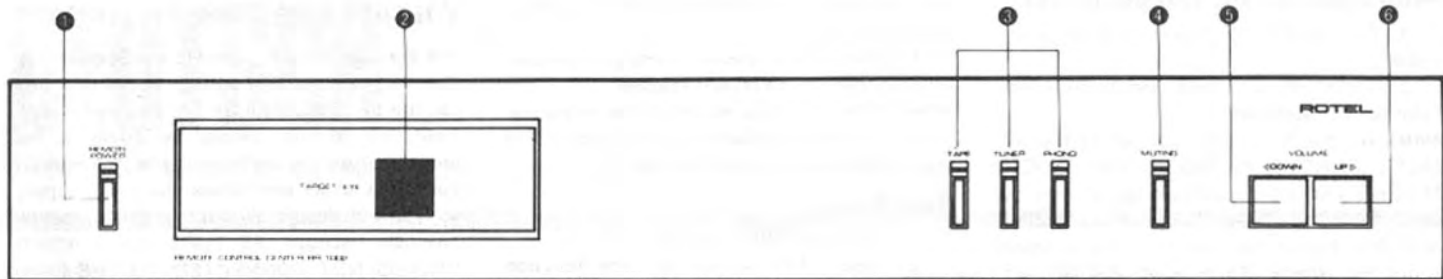

(7) Infrared Eye

To send operating command, the infrared eye transmits an infrared beam to the target eye on the main unit.

(8) Indicator Lamp

This indicator glows when the remote transmitter unit is emitting an infrared beam.

(9) POWER Switch

Press this button to turn on power in amplifier, tuner (or receiver), turntable, and tape deck. Press the button a second time to turn off.

(10) Function Selector

Select the desired program source; press TAPE button for sound from tape deck, AM button for AM broadcast from tuner or receiver, FM button for FM broadcast, and PHONO button for sound from turntable.

(11) Station Buttons

These buttons are used to call up preset stations stored in the memory of tuner or receiver. The numbers 1 through 6 above the respective buttons correspond to the station button numbers on the tuner or receiver (station button 6 is used only for the tuner).

(12) Cassette Control Buttons

These buttons are used to control the tape deck transport mechanism. Press ■ button to disengage playback, record, fast-forward, or rewind mode.

Use ● button when you wish to record. This button works differently from the REC (●) button on the tape deck. Press the button to put the deck in the recording standby state, and then press ■ button to start the tape.

Press ◀ button to rewind tape.

Press ▶ button to play back tape.

Press ►► button to advance tape rapidly forward.

Press ■ button for temporary suspension of tape motion during recording or playback. Pressing the button a second time will restart the tape, returning the deck to mode before interruption.

(13) Start/Reject Button

Use this button to control the turntable. Press the button to start the play, and press it a second time to stop the play, and the tone arm returns to the arm rest.

(14) Volume Control Buttons/Audio Muting Button

These buttons work in the same manner as those for UP/DOWN volume control buttons and audio muting button on the main unit.

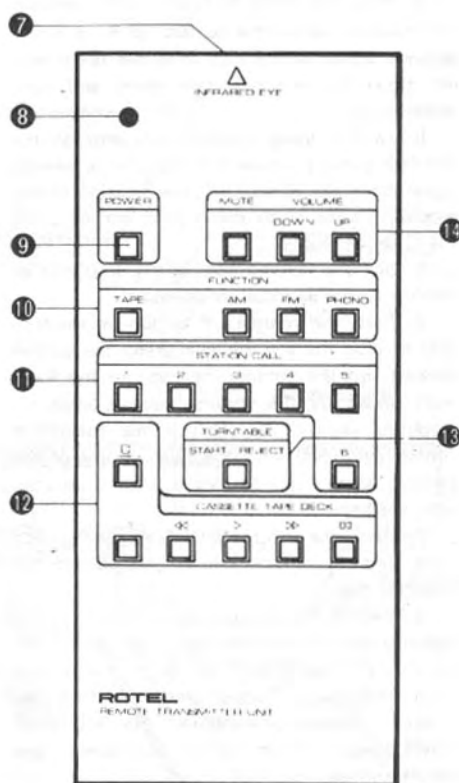

OPERATION

- The RR-700 Remote Control Center lets you remote-control each system component by means of an infrared beam. The RR-700 consists of a main unit with a target eye (infrared beam receptor), and remote transmitter unit with infrared eye (infrared beam emitter). With the transmitter unit in your hand, you can control power on/off throughout the entire system, selection of program source, calling up preset broadcast stations, starting or stopping record play, operation of cassette mechanism, and volume level of the sound. All this can be done from where you are, with no need to move to the equipment and handle it directly.

- Fit three SUM-3 ("AA") dry batteries into the remote transmitter unit, correctly matching the polarity markings "+" and "-". The life expectancy of the batteries in the unit should be about two years. If the indicator lamp does not light up even if the control buttons are operated, or if the unit malfunctions, the cause may be dead batteries. Replace all three batteries with new ones.

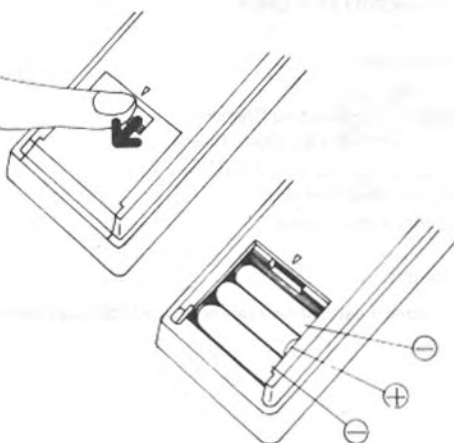

- When you use the remote transmitter unit to control the system, the infrared eye of the unit should be oriented towards the target eye on the main unit. If there is an obstacle between the transmitter and the target eye that

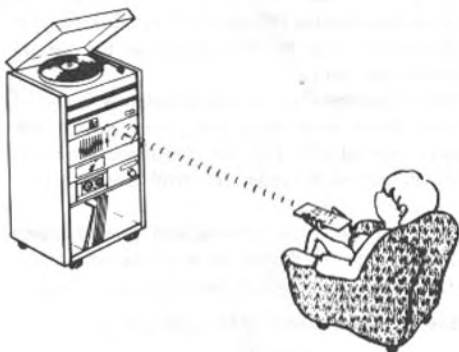

blocks the path of the light beam, or if you are too far away from the main unit, remote control is impossible. Be sure that you are in a position where you can see the main unit without obstruction, and not more than six meters away from the main unit.

- Before beginning operation, make sure that power cord connections for each component, DIN cord connections for remote-control, RCA cord connections, etc. are all correct.

- Set the function selector on amplifier or receiver to PHONO, and tape monitor switch to TAPE 1. Set the volume control on the amplifier or receiver to position zero (0).

Initial Operation and Function Checks

1. Plug the RR-700 power cord into a wall outlet.

2. TAPE indicator (red) and TUNER indicator (green) both light up.

Note: At this time, one or more of the REMOTE POWER, PHONO, and/or AUDIO MUTING indicators may light up. If they do, press REMOTE POWER button or AUDIO MUTING button to turn off the indicator above the button. To turn off PHONO indicator, press TUNER button; the TUNER indicator will light up instead.

3. Press TAPE button to turn off the indicator above the button.

4. Press REMOTE POWER button and the red indicator above the button lights up. Next, activate power buttons on amplifier (or receiver), tuner (or receiver), tape deck, and turntable.

5. In that state, TUNER indicator on the RR-700 glows to show that the unit is feeding signal from the tuner (or tuner section of the receiver). Tune in to the desired station using the tuner or receiver.

6. Set the volume control on amplifier or receiver to the appropriate position.

7. Press the volume UP button on the RR-700 to raise the volume level; keep the button pressed and the volume increases to the fixed level preset by the volume control knob on amplifier or receiver. This is the maximum controllable level with the given setting of the control knob. If you desire higher volume, reset the knob to a higher level.

8. Press the volume DOWN button on the main unit to reduce the volume to normal listening level.

9. Orient the infrared eye of the remote transmitter unit towards the target eye on the main unit. Press POWER switch on the remote transmitter unit. Check that each time the POWER switch is pressed, the REMOTE POWER indicator on the main unit goes on and off alternately.

When the remote transmitter unit POWER switch is activated, the control buttons on the unit are operative.

10. After completing the above procedures to confirm normal operation, turn off the power by pressing REMOTE POWER button on the main unit or POWER button on the remote transmitter unit.

Note: that the main unit is constantly supplied with power even after the power switch has been turned off. Do not disconnect the a.c. power cord of the main unit from the outlet.

Now you can enjoy listening and have complete control over the system with the remote transmitter unit, following the steps below.

Listening to AM/FM Broadcast

1. Turn on POWER switch.

2. Press AM or FM button on the function selector.

3. Press the station button for which the desired broadcasting station is memorized.

Note: Use station button 6 only for tuner (RT-700/RT-700L).

4. Keep volume control button UP pressed until desired volume level is reached.

Record Playing

1. Turn on POWER switch.

2. Press PHONO button on the function selector.

3. After making sure a record is placed on

the turntable, press START/REJECT button to start play.

4. Keep volume control button UP pressed until desired volume level is reached.

Note: When placing a record on the turntable, be sure to set the speed and size selectors on the turntable according to the record.

Tape Playback

1. Turn on POWER switch.

2. Press TAPE button on the function selector.

3. After making sure a cassette tape is properly loaded into the cassette deck, start playback using the cassette control buttons.

4. Keep volume control button UP pressed until desired volume level is reached.

Note: When loading cassette tape, set tape selector on the tape deck to the position that accords with type of tape.

Recording Program Sources

1. Turn on POWER switch.

2. Press appropriate button on the function selector, AM, FM, or PHONO, according to the program source you wish to record, and put the equipment into play mode.

3. After making sure a cassette tape is in the tape deck, start recording by using cassette control buttons.

4. The program source can be heard during recording.

Note: The signal sent through the TAPE OUT terminals on the RR-700 is not affected by operation of volume control, etc.

VOLTAGE SELECTION

Not available for U.K., Canada and Scandinavia

The unit is a variable voltage equipment that can run on 120V, 220V or 240V power supply. Your unit should already be preset at the proper voltage for use in your area. However, if you move to an area where the power supply voltage is different, the voltage setting can be manually changed. **BE SURE THAT YOUR UNIT IS NOT CONNECTED TO THE POWER SOURCE BEFORE ATTEMPTING TO MAKE THIS CHANGE.**

To check the voltage setting, remove the name plate on the rear panel and locate the VOLTAGE SELECTOR. Use a screwdriver to turn the voltage selector to the required voltage.

SPECIFICATIONS

MAIN UNIT

IC9
Transistor24
Diode38
Ceramic Oscillating Element1
Relay2
Light Emitting Diode (LED)5
Range of Operation6m
Power Requirement120V/60Hz, 220V/50Hz, 240V/50Hz, 120, 220, 240V/50-60Hz
Dimensions (Overall)430 (W) x 66 (H) x 292 (D) mm 16-15/16" x 2-19/32" x 11-1/2"
Weight3.6kg/7.92 lbs.

TRANSMITTER UNIT

IC1
Transistor3
Diode2
Ceramic Oscillating Element1
Infrared Light-Emitting Diode2
Light Emitting Diode (LED)1
Power RequirementSUM-3 (UM-3) dry battery (1.5VDC) x 3
Dimensions (Overall)74 (W) x 24 (H) x 172 (D) mm 2-29/32" x 15/16" x 6-25/32"
Weight185g/6.53 ozs.

• Specifications and design subject to possible modification without notice.