

ROTEL®

MULTI-ROOM COMPONENT SYSTEM



Technical Overview and Installation Manual

RMZ950



This symbol is to alert the user of the presence of dangerous voltages inside the enclosure of the RMZ950. To reduce the risk of electric shock do not remove any parts of the RMZ950.

Read all the instructions before connecting or operating the RMZ950. Pay particular attention to the safety information. Keep this manual so you can refer to these safety instructions.

WARNING: *There are no user serviceable parts inside. Refer all servicing to qualified service personnel.*

WARNING: *To reduce the risk of fire or electric shock, do not expose the RMZ950 to moisture or water. Do not allow foreign objects to get into the enclosure. If the unit is exposed to moisture, or a foreign object gets into the enclosure, immediately disconnect the power cord from the wall. Take the unit to a qualified service person for inspection and necessary repairs.*

Clean the RMZ950 only with a dry cloth or a vacuum cleaner.

Place the RMZ950 on a fixed, level surface strong enough to support its weight. Keep the RMZ950 away from radiators, heat registers, stoves, or any other appliance that produces heat.



This symbol is to alert the user of important operating instructions in the owner's information accompanying the RMZ950.

Keep the ventilation inlets on the top of the unit unobstructed. If the RMZ950 is placed in an enclosure, there must be sufficient ventilation of the enclosure to allow proper cooling.

Connect the RMZ950 to the power outlet only with the supplied 3-pin grounded power supply cable or an exact equivalent. The cable should be connected to a properly grounded 3-pin wall outlet. Do not modify the supplied cable in any way. Do not use extension cords.

Do not route the power cord where it will be crushed, pinched, bent at severe angles, exposed to heat, or damaged in any way. If the cable shows any sign of wear or damage, immediately stop using it and obtain a proper replacement from a qualified service agency or from the Rotel service department.

If the RMZ950 shows signs of improper operation, or if it has been dropped or damaged in any way, immediately disconnect the power cord from the wall. Take the RMZ950 to a qualified service person for inspection and necessary repairs.

1	Overview	1
1.1	Basic Architecture	1
1.2	Controlling the Remote Zones	1
1.3	System Flexibility	1
2	Component Description	3
2.1	RMZ950 Controller/Amplifier	3
2.2	RR950 IR Remote Control	4
2.3	RSM900 Sensor/Display	4
2.4	RKP900 Keypad	4
2.5	Data Cable and Connectors	5
2.6	Speaker and Cable Connections	5
3	System Planning	6
3.1	Initial Considerations	6
3.2	RMZ950 Basic Setup	6
	3.21 Placement:	6
	3.22 Connections:	6
	3.23 IR "Flood" Emitter	6
	3.24 IR "Repeater" Jacks	7
	3.25 N/C Jack	7
3.3	Zone Configuration	7
	3.31 Basic Zone Complement	7
	3.32 Control Code Generators	7
	3.33 Loudspeakers	7
4	Installation Guide	8
4.1	The RMZ950 Controller/Amplifier	8
	4.11 Source connections	8
	4.12 Speaker Wire Connections	9
	4.13 Preamp outputs	10
	4.14 Data cable connections	10
4.2	Zone Control Devices	11
	4.21 RSM900 Sensor/Display	11
	4.22 The RKP900 Keypad	13
4.3	Zone Connection Strategies	14
5	System Setup	15
5.1	Source Component Setup	15
	5.11 Default operating mode	15
	5.12 Optional operating modes	15
	5.13 Setup sequence	15

5.2	IR System and Control Codes	16
	5.21 OVERVIEW	16
	5.22 Front Panel IR Flood Emitter	17
	5.23 Rear Panel IR Emitters	17
5.3	AC Line Considerations	17
	5.31 AC for the RMZ950	17
	5.32 AC for Source Components	17
	5.33 AC Power Recommendations	18
	5.34 "Power Toggle" Command	18
5.4	Advanced Multi-Zone Systems	19
	5.41 Eight & Twelve Zone Systems	19
	5.42 Large System Configuration	19
	5.43 Source Connections	19
	5.44 IR Flood Emitter Connections	19
	5.45 IR Repeater Connections	21
	5.46 AC Connections	21
	5.47 "Power Toggle" Set-up	21
	5.48 Note on "Engaged" Indicator	21

6	Operation	22
6.1	Preliminary Observations	22
6.2	RR950 Hand-held Remote Control	22
	6.21 Input Selector Buttons	23
	6.22 Tuner control buttons	23
	6.23 CD control buttons	23
	6.24 Tape control buttons	23
	6.25 Laser Disc control buttons	23
	6.26 MUTE	24
	6.27 VOLUME UP/VOLUME DOWN	24
	6.28 STBY	24
	6.29 "X"	24
6.3	RKP900 Keypad	24
	6.31 "Obvious" key functions	24
	6.32 "Hidden" key functions	24
	6.33 TUNER commands	25
	6.34 CD commands	25
	6.35 TAPE commands	25
	6.36 LASER DISC commands	26
	6.37 SYSTEM commands	26
6.4	RSM900 Sensor/Display	26
	6.41 Overview	26

7.0	Conclusion	27
------------	-------------------	-----------

1.1 Basic Architecture

The Rotel RMZ950 Multi-Room Control System distributes audio signals from a single set of source components to as many as four separately controlled remote zones or listening areas. The centrally located RMZ950 controller/amplifier contains source selection, microprocessor controlled communications circuitry and independent preamplifier/power amplifier sections for all zones.

1.2 Controlling the Remote Zones

Users can select either of two ways to control remote zone operation. The first is the RR950 hand held remote. This generates infrared (IR) control pulses read by the wall-mounted RSM900 sensor/display. The RSM900 sensor/display then transmits commands to the RMZ950 through hard-wired connections.

The second method uses the optional wall-mounted RKP900 keypad to transmit commands directly to the RMZ950. The RKP900 is also hard-wired to the RMZ950 controller/amplifier.

Users can select a combination of sensor and keypad operation for any zone. The system accepts inputs from up to two sensor/displays and two keypads (for a total of four input devices) per zone.

1.3 System Flexibility

The Rotel RMZ950 Multi-Room Control System is exceptionally flexible. In addition to the RMZ950 controller/amplifier, a simple two zone system might include just one RR950 hand held controller/RSM900 IR sensor/display combination for one zone and one RKP900 keypad in the second.

In its most elaborate form, the RMZ950 system accepts commands from four separate zones via eight IR sensor/displays and eight additional keypads.

Section 1 • System Overview

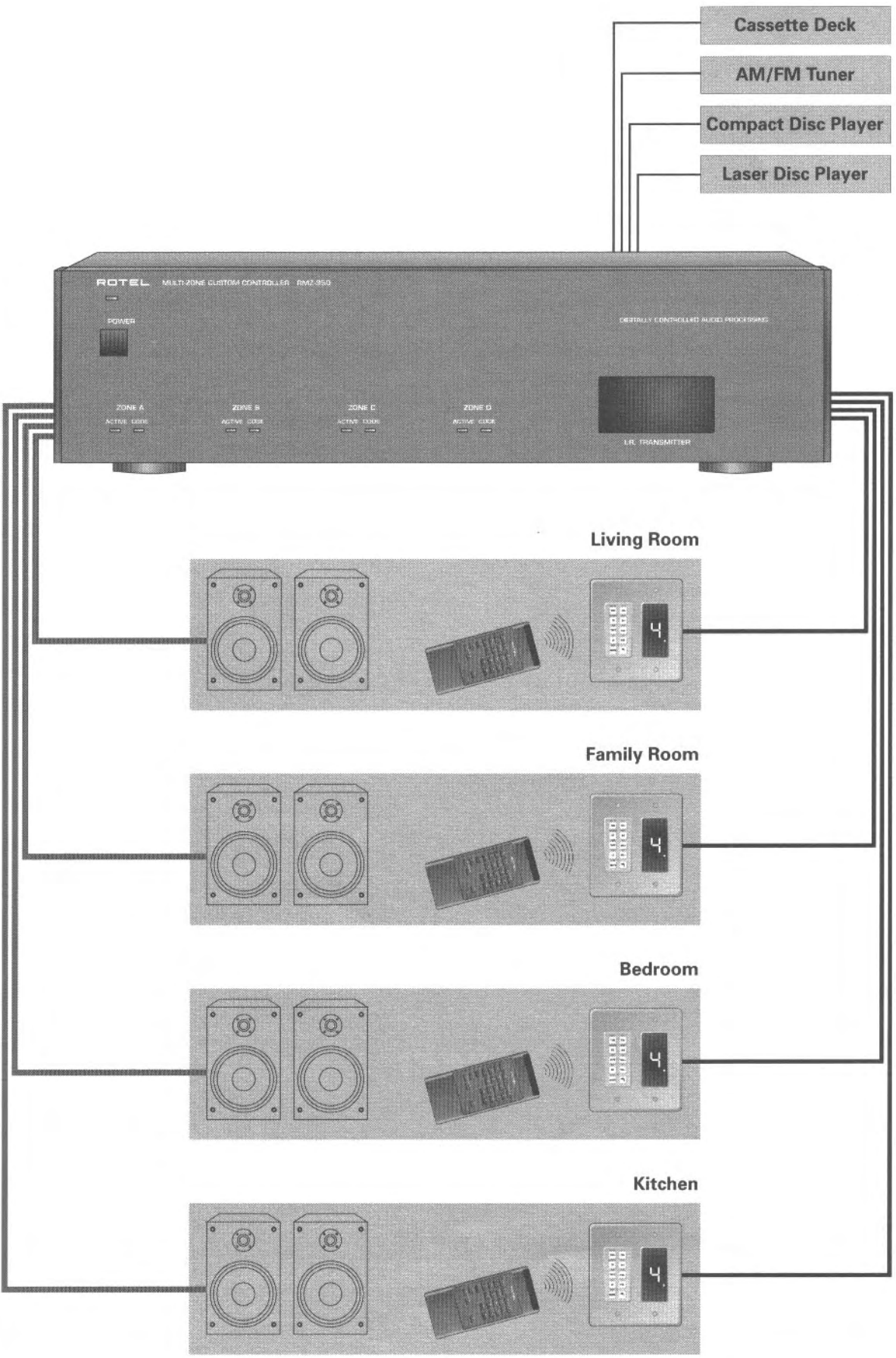

2.1 RMZ950 Controller/Amplifier

The RMZ950 Controller/Amplifier is the heart of the RMZ950 Multi-Room Control System. It features:

- Four separate microprocessor-controlled stereo preamplifier/power amplifier sections, one for each remote zone
- RCA inputs for up to four sources
- "Loop through" RCA outputs which allow these sources to connect directly to an additional entertainment system if desired
- RCA line level preamplifier outputs
- Single-banana type amplifier outputs
- Control data input for each zone is via industry-standard 6 pin IDC/ Methode connectors
- RCA output jack for RC-5 remote control protocol components
- Four mini-plug IR repeater outputs
- Two polarized AC convenience outlets with 100 watts capacity each: one switched to allow easy remote control of total system power if desired, the other unswitched
- Front panel LED indicators for Power On/Off, zone status, command pulse processing
- High power front panel IR "Flood" emitter to transmit remote zone commands to associated source components

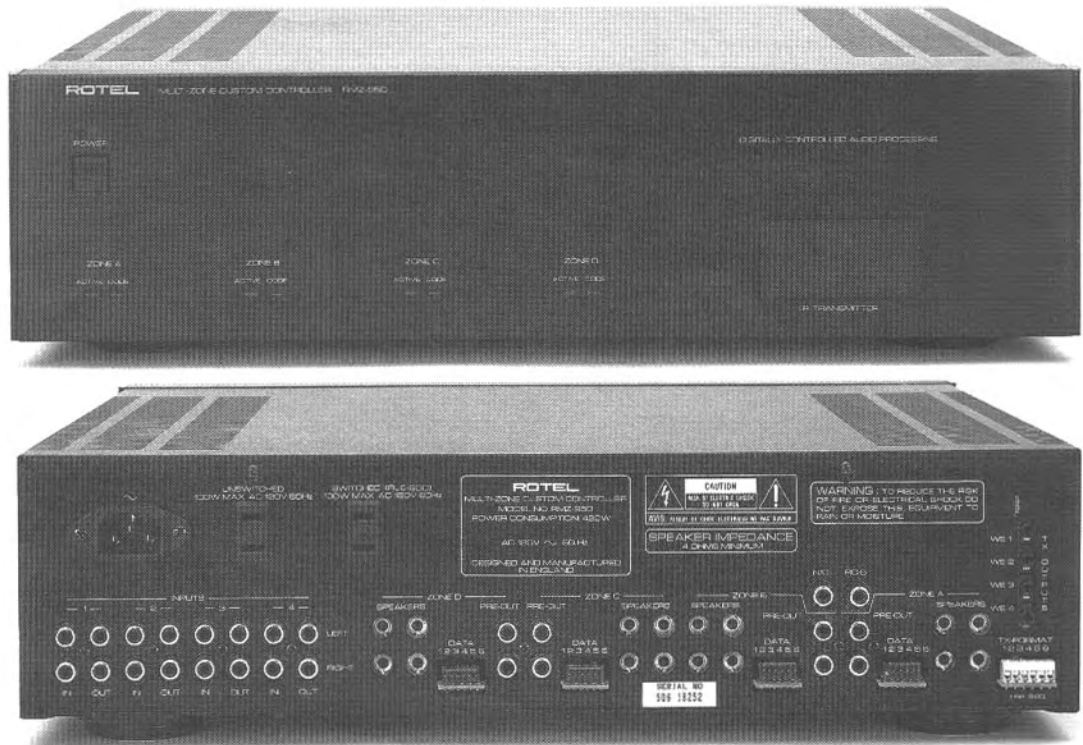

2.2 RR950 IR Remote Control

The RR950 remote control serves a dual purpose. In addition to providing dedicated pushbuttons for the most needed functions of both the RMZ950 controller/amplifier and source components, it also serves as a quick set-up tool during initial configuration. Normal operating mode is explained in Section 6.2. Details of initial set-up will be found in Section 5.13.

The RR950 has a special high intensity IR transmitter. In conjunction with the system's sensitive receiver modules, this transmitter assures reliable operation under a wide variety of conditions.

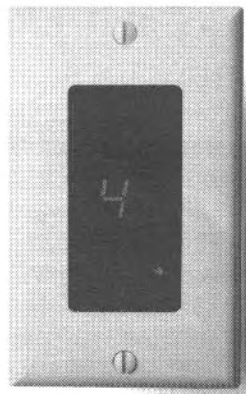
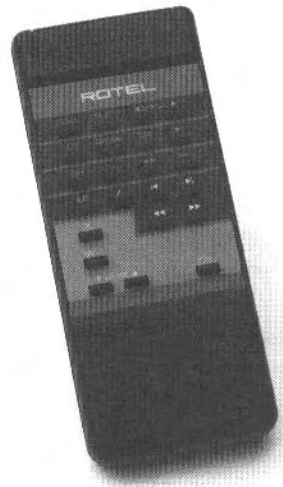

NOTE: An RSM900 connected to the Zone A data input MUST be used during initial set-up, particularly with systems where non-Rotel source components are included. Details are in Section 5.13.

2.4 RKP900 Keypad

The RKP900 Keypad provides a remote zone control alternative to the RR950. The keypad can be used as a stand-alone control device although it is most functional with the RSM900 sensor-display. Its 10 key design is the optimum balance between flexibility and simplicity. Zone input choice, zone volume up/down and mute are single key stroke commands. A maximum two-key sequence accesses more sophisticated source operation ("next track" on a CD for example). In addition, the RKP900 allows total system shut-down from a remote location. It mounts conveniently in a standard single width wall box or in a dual width box with a RSM900 sensor/display.

2.3 RSM900 Sensor/Display

The wall-mounted RSM900 Sensor/Display receives commands from the RR950 hand held remote and, after processing to ensure maximum data integrity, sends these codes to the RMZ950 controller/amplifier. In addition, the RSM900 provides a continuous system status check at each remote location by displaying a range of easily-understood alphanumeric characters. You'll find details of the display in Sections 5.13 (Setup) and 6.4 (Operation).

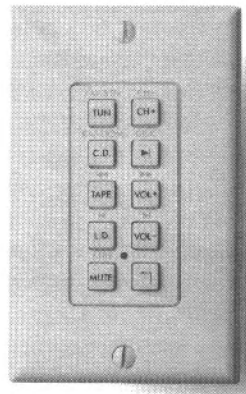

2.5 Data Cable and Connectors

The data path between the RMZ950 controller/amplifier and RSM900 sensor/displays and RKP900 keypads must be made with cable with six conductors plus a braided outer shield. We recommend a Belden 9536 equivalent for best results. Other six conductor + shield cable may be perfectly acceptable but RMZ950 system data connectors work only with cables using 24 gauge conductors. Make sure that all data cables conform to this requirement.

Note: Belden 9536 cable is available from any Belden wire distributor. Or, it can be ordered from Liberty Wire and Cable by calling (719) 260-0061.

Data cable termination is via industry-standard 6 pin connectors made by IDC, Methode and others. (The Methode part number is 1300-106-424.) Pin-out configuration and termination hints are found in Section 4.12 (b).

2.6 Speaker and Cable Connections

Unshielded two conductor 16 gauge (AWG) "zip cord" is the minimum acceptable standard for connections between the RMZ950 controller/amplifier and zone loudspeakers. Particularly long runs may call for use of heavier wire. Specific recommendations are found in Section 4.12 (a).

The RMZ950's amplifier outputs are recessed banana-type receptacles designed for single plugs. So-called "double bananas" are not suitable as rear panel space and international safety requirements preclude use of 3/4" centers. Again, see Section 4.12 (a) for more details.

3.1 Initial Considerations

The RMZ950 controller/amplifier can be used in either of two basic ways.

- a) As a stand-alone control center for a multi-zone distribution system using dedicated source components.
- b) As a control center which shares source components with an existing music or home theater system.

Specific system configurations will determine the best location for the RMZ950 controller/amplifier. See Section 3.2 immediately below for details.

3.2 RMZ950 Basic Setup

3.21 Placement:

The RMZ950 controller/amplifier is designed to cosmetically complement high quality home entertainment components. Place it on a stable surface in an equipment rack or cabinet. Note that the RMZ950 is slightly deeper than most sources (tuners, CD players, cassette decks, etc.) and should not generally be placed on top of these units.

3.22 Connections:

Make sure that you have enough room to run all the connecting cables and dress them appropriately behind the RMZ950. Although we'll explain each connection fully in following sections of this manual, take a quick glance through the following list of possibilities and decide how much space you'll need. Also remember that these cables will make the RMZ950 much more difficult to move when they are connected. Plan accordingly.

- a) Four pair of RCA to RCA interconnects – one from each source.
- b) Four more pair of RCA to RCA interconnect cables – one each to the appropriate input of the main system's preamplifier, etc., from the corresponding "loop

through" output on the RMZ950 (These may not be needed if the RMZ950 is used as a stand-alone controller).

- c) Eight heavy gauge zip cord pairs (two for each zone) terminated with single banana plugs.
- d) Four six-conductor+shield data cables, each terminated with the proper strip connector.
- e) One shielded RCA to RCA interconnect for RC-5 remote control code connection.
- f) Up to four pair of RCA to RCA interconnects to power amplifiers from the corresponding zone's "Pre-out" terminals.
- g) Up to four mini-plug (3.5 mm) cables from the RMZ950's "Infra Red" outputs to remote IR transmitters.
- h) Additional RCA to RCA shielded cables and loudspeaker connections as required for systems using more than one RMZ950 controller/amplifier.
- i) Up to six "TX-FORM" terminal block jumper wires needed when cascading multiple RMZ950 controller/amplifiers.

We **STRONGLY RECOMMEND** that you attach a tag or strip to each cable and wire that permanently and positively identifies it. This will help in any required troubleshooting immediately after the installation as well as make future service calls or system add-ons much less frustrating.

Avoid vague identifiers ("Tape Deck," for example) in favor of carefully defined lines such as "To Input 3 from tape deck." However well you remember each installation just after completing it, you **WILL FORGET** by the next time you see it again.

3.23 IR "Flood" Emitter

The RMZ950 has a high intensity front panel IR "flood" emitter designed to transmit commands from the remote zones to the appropriate source component. Although exact performance will

vary, this high power transmitter has an effective operating range of approximately 40' under normal conditions.

If the RMZ950 is on an open shelf, the emitter's signal must first travel to an IR-reflective surface (an opposing wall, for example) and then to the source component.

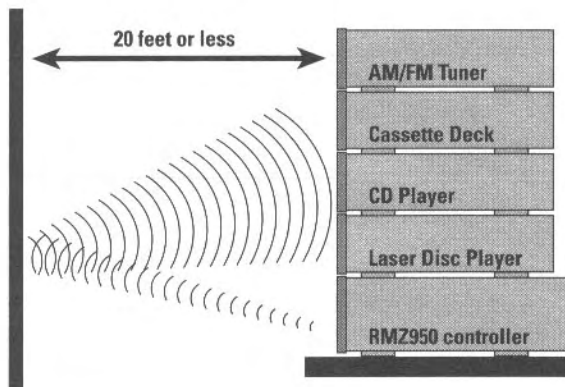

Keep total IR signal travel to 40' or less. Remember that it must travel to a hard reflective surface and then back again.

3.24 IR "Repeater" Jacks

Remember that the RMZ950 also has four rear panel IR output jacks for use with industry standard IR repeaters (made by Xantech and others). Use these in situations where output from the front panel "Flood" IR emitter is blocked from the source components by a door, full depth shelf, etc.

3.25 N/C Jack

This RCA connector, located just to the left of the RC-5 output, is unused at present.

3.3 Zone Configuration

3.31 Basic Zone Complement

Each remote zone includes at least one control code generator and a pair of loudspeakers.

3.32 Control Code Generators

The code generator may be a RR950 hand held remote and an RSM900 sensor/display combination. It can also be a stand-alone RKP900 keypad. Details are in Sections 5.13 (Setup using the RR950), 6.2 (Operation with the RR950) and 6.3 (Operation with the RKP900).

Remember that the RSM900 sensor/display also provides visual clues to total system operation. Details are found in Section 5.13 (Setup) and 6.4 (Operation).

Most zones will use multiple control code generators with the combination of one RSM900 sensor/display and one RKP900 keypad being the most common.

Mounting both the sensor/display and keypad in one double-width wall box carries several advantages:

- a) It simplifies the installation — all control cables run to a single location.
- b) It focuses the user on one location - he or she either walks to the keypad or aims the hand held remote at the wall-plate.

The RSM900 sensor/display reads infrared signals generated by the RR950 hand held remote and, after translating them into a digital code that is highly resistant to interference, sends them to the RMZ950 controller/amplifier. The RKP900 simply translates key pushes into digital code before sending them to the controller/amplifier.

3.33 Loudspeakers

These will vary with installation requirements and user expectations. The RMZ950's amplifier sections are optimized for impedance loads of four (4) ohms or higher.

4.1 The RMZ950 Controller/ Amplifier

4.1.1 Source connections

Connect LINE LEVEL sources (CD player, tuner, etc.) to the RMZ950's rear panel as follows.

- a) Using shielded RCA-RCA cables, connect the source's output to the corresponding input on the RMZ950. Connect analog outputs from the source components as indicated to assure clear operation with both the RR950 hand held remote and the RKP900 keypad:

Tuner	➔	RMZ950 Input 1
CD player	➔	RMZ950 Input 2
Tape player	➔	RMZ950 Input 3
Laser disc	➔	RMZ950 Input 4

Make sure to observe correct channel continuity from source to RMZ950. The RMZ950's RCA inputs are labelled for easy identification with Left Channel connections on the top row and Right Channel connections on the bottom row.

NOTE 1: The RMZ950 does not accept a phono cartridge's output directly. If required, use a separate phono preamp (such as Rotel's RQ970BX) to boost phono signal to line level.

NOTE 2: To simplify system operation, we strongly suggest using only FIXED LEVEL source outputs to the RMZ950. If no FIXED LEVEL outputs are available, use variable outputs but make sure that the source component's level control is turned up sufficiently but not so high as to overload the RMZ950's inputs.

- b) If the source is shared by another system, connect the appropriate RMZ950 source output to the appropriate input of the main system's preamplifier, etc.

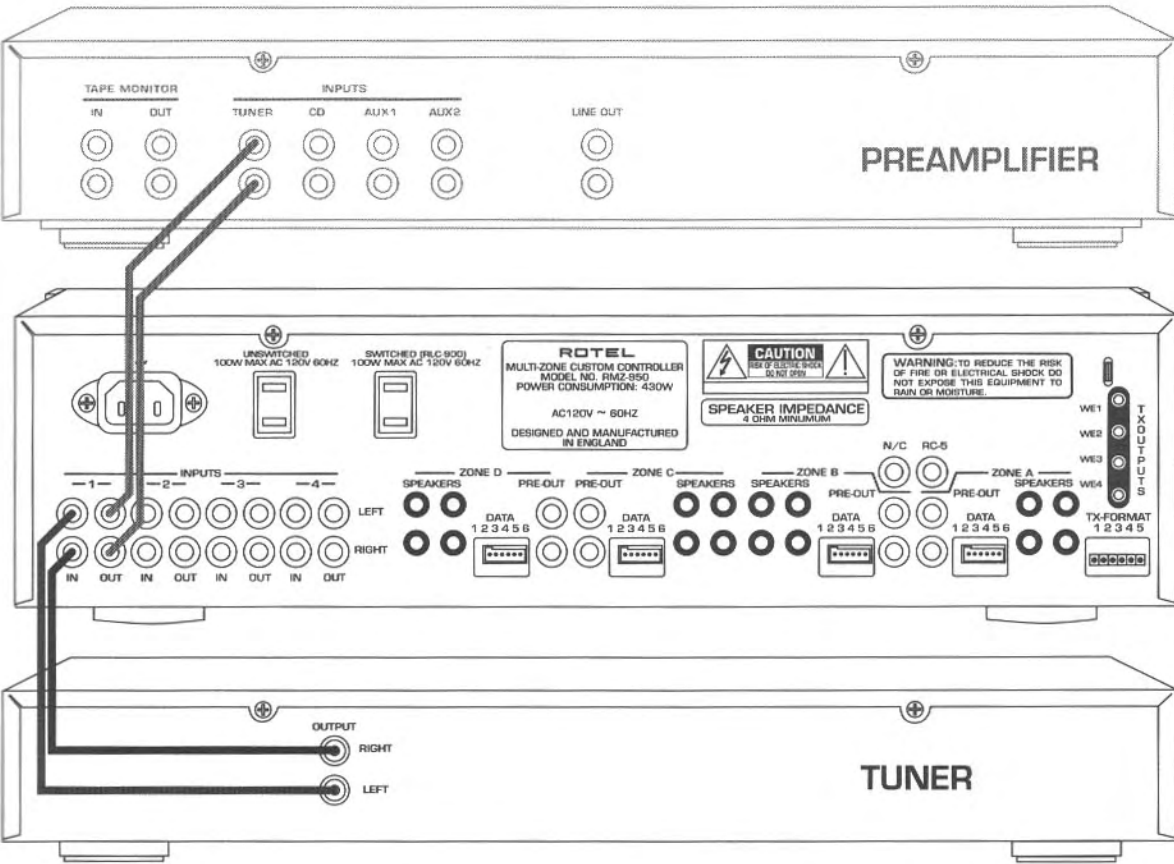

Tuner connected to Source 1 input with optional pass-through to preamp for shared use with separate system.

4.12 Speaker Wire Connections

NOTE: These Zone Connection instructions focus on one zone only. Connections for all other zones are identical except for the mirror-image connector placement on alternate zones.

Use the supplied single-banana connectors for all speaker wire terminations. Double-bananas with 3/4" centers will NOT work. Some single-banana designs with large barrels may be too wide.

- To open the supplied banana connectors, hold the plastic insulating barrel in one hand and twist the center pin conductor clockwise with the other. The pin conductor will drop through the rear of the barrel.
- Using a small straight-blade screwdriver, back off the set screw by turning it counter-clockwise until there is enough

room in the pin's rear recess to insert the speaker wire conductor. Make sure there is good metal-to-metal contact between the recess walls and the speaker wire conductor. Then tighten the set screw securely and gently pull the wire and pin assembly in opposite directions to make sure the joint is solid.

- Screw the barrel back on the pin conductor/wire combination and insert into the appropriate banana recess on the RMZ950's rear panel.

Repeat this procedure three more times to complete connections for one zone.

Remember to observe proper polarity when connecting all loudspeakers. The RMZ950's banana receptacles and the banana connectors themselves are color-coded Red for "+" and Black for "-." The amplifier's "+" output should connect to the proper speaker's "+" terminal.

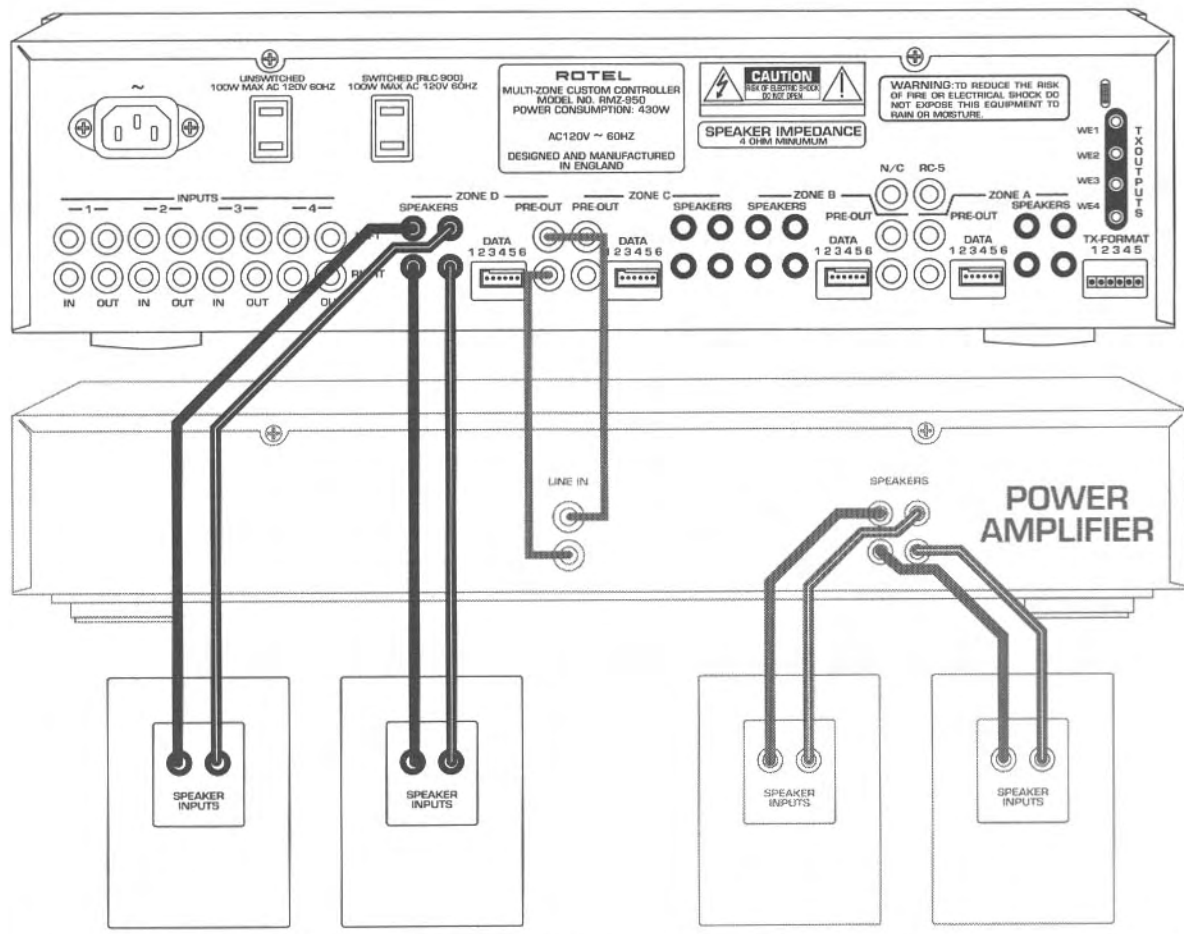

Speaker outputs from one zone of RMZ950. Also showing preamp output connections for use with optional power amplifier.

BE CAREFUL AND BE PATIENT. This is an admittedly tedious task, particularly when you are hooking up speakers for all four zones, but it is essential for maximum system enjoyment.

“Out of phase” loudspeaker hookups (where one speaker in a stereo pair is inadvertently connected “+” to “-” and vice versa) may not be immediately noticeable but will not be as pleasing in the long term as a properly connected stereo pair.

The long runs from amplifier to speaker typically found in multi-zone installations demand heavy gauge, low resistance speaker wire. Small diameter wire reduces effective amplifier power and adds substantial distortion to the audio signal. Avoid problems by following these minimum recommendations:

- Under 50'* ➔ *16 gauge wire*
- 50' - 150'* ➔ *14 gauge wire*
- More than 150'* ➔ *12 gauge wire*

Loudspeaker runs over 300' are discouraged.

4.13 Preamp outputs

Two RCA jacks (Left and Right Channel) labeled “Pre-out” provide line level output controlled by the corresponding zone command devices. If a zone requires additional amplification, use RCA-RCA shielded interconnects from these outputs to a separate power amplifier’s unbalanced line inputs.

Each zone’s preamp output is fully buffered and may be used either independently or with the RMZ950’s internal amplifiers to provide additional flexibility for demanding installations.

The Rotel RB970BX power amplifier is a particularly good choice for auxiliary amplification as its input sensitivity spec is identical to that of the RMZ950’s power amplifier sections.

4.14 Data cable connections

Data communication to and from the RMZ950 controller/amplifier and the remote zone’s RSM900 sensor/displays and RKP900 keypads is via 6 conductor shielded cable. We recommend Belden 9536 or the equivalent. (*Note that the IDC/Method connectors only accept cable with 24 gauge conductors.*)

We also recommend that you run each zone’s data cable and speaker cables together to save time. There is absolutely no performance penalty for doing so.

The shield is absolutely essential in maintaining data integrity over the long runs between the controller/amplifier and a zone’s control code generating devices. Make sure that the shield is firmly connected at both the RMZ950 and at any command device terminal.

NOTE: *Only one data cable needs to run from the RMZ950 to each zone. Multiple sensor/display and keypad combinations in one zone should be wired via series connections detailed in Section 4.3.*

PROPER DATA CABLE TERMINATION IS CRITICAL. Use the following color code guide to ensure proper operation:

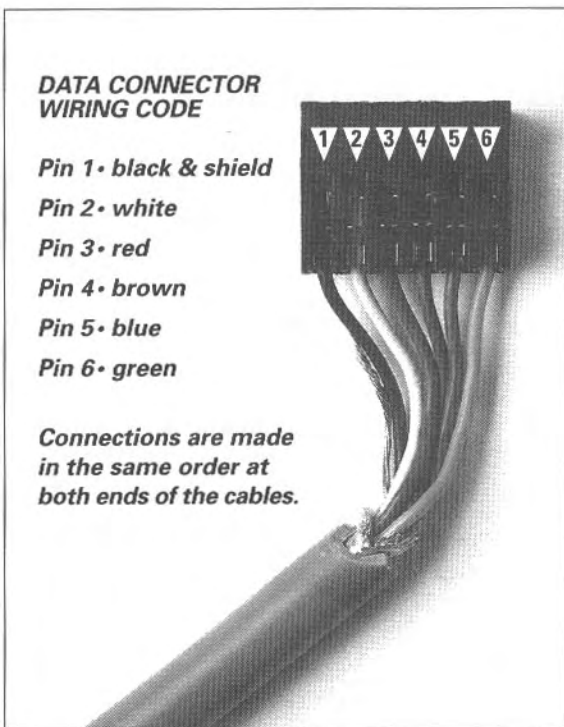

Connectors for the RSM900 sensor/displays and RKP900 keypads should be wired to follow the same color coding.

The supplied IDC/Method connectors need to be crimped to lock to the data cable's 24 gauge conductors. Available crimping tools range from a simple hand held keyed blade type to a heavy duty plier style device. If you anticipate a number of RMZ950 installations, we suggest you obtain the heavier crimping tool.

NOTE: Do not use a screwdriver, metal ruler or knife blade to "crimp" these connections. You may think these tools will work but you will be mistaken. USE ONE OF THE DEDICATED CRIMPING TOOLS SPECIFICALLY DESIGNED FOR THESE CONNECTORS.

- Strip about 1 1/2" to 2" of the outer cable insulation using a wire stripper, cutting pliers or sharp knife.
- Separate the braided outer shield wires from the conductors and twist them into one "pig-tail."
- DO NOT strip insulation off the six individual conductors as the connector automatically makes contact with the conductor core when crimped.
- Place the shield pig-tail into slot 1 (left hand side) of the connector and press down *lightly* with the crimping tool to hold it in place.
- Place the BLACK conductor immediately on top of the shield pig-tail in slot 1, hold it in place and push down harder with the crimping tool until you hear a slight "click." The shield pig-tail and black-insulated conductor should now be locked into slot 1. (The clicking sound also tells you that the connector slot contacts have pierced the conductor's insulation.) **Test the connection by pulling gently on both shield and conductor.**
- Continue the process following the color code guide above until all other conductors are locked in the appropriate connector slots. Remember that slot 1 is the

ONLY ONE to get both the shield and a conductor. All other slots receive only a conductor.

After attaching the cable conductors to the connector, snap it onto the appropriate zone's 6 pin data terminal on the RMZ950's rear panel. Be careful to center the connector over the terminal pins before inserting.

The maximum data cable length for guaranteed operation is 300'. Even longer lengths may be practical in some installations with low RF (Radio Frequency) and EMI (Electro-magnetic interference).

4.2 Zone Control Devices

4.21 RSM900 Sensor/Display

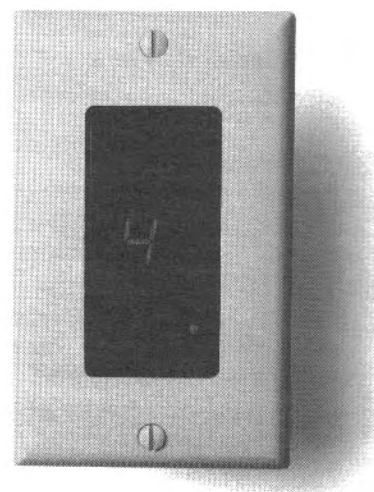

- a) The RSM900 Sensor/Display mounts in a single-width wall box or in a double width box with the RKP900 keypad.

PLACEMENT SUGGESTIONS: Exact placement will vary with each installation but we strongly recommend AGAINST placement where the RSM900 will be exposed to direct sunlight, powerful fluorescent illumination or the output of a high intensity spotlight, etc. These light sources contain high levels of infrared energy themselves and may cause intermittent operation by saturating the RSM900,

Also, avoid infrared "loops" by making sure that an RSM900 sensor/display is *not* placed where it might pick up signals from a source component's IR repeater or the RMZ950's IR "flood" emitter.

Lastly, make sure that each RSM900 is on a relatively uninterrupted "line-of-sight" path to all likely locations from which the hand held RR950 remote might be used. You'll find the RSM900/RR950 combination much less susceptible to signal interference than other IR remote control links but conservative planning will ensure dependable operation under an even wider variety of conditions.

INSTALLATION NOTE: *The RSM900's rear circuit board is purposely mounted in the opposite direction compared to the board on the RKP900 to avoid a cable jam at the bottom of a double width wall box should both devices be mounted in one box. Thus, the RSM900's IN and OUT data cable terminals will be at the "top" and the DIP switches at the "bottom" of the board when the RSM900 is properly installed.*

Each RSM900 *must* be set for the particular zone it is operating in. Set zone IDs by adjusting the RSM900's board-mounted DIP switches as follows:

When setting the DIP switches, we suggest orienting the RSM900 so that the printed IDs on the circuit board can be easily read. After setting both DIP switches for the intended zone, invert the RSM900 before installing it in the box or the alphanumeric display will be upside down.

Note: *Improper switch settings will not interfere with data communication TO the RMZ950 so zone operations will be unaffected. However, improper switch settings will cause the RSM900 to display inaccurate and confusing system status information.*

Zone switches

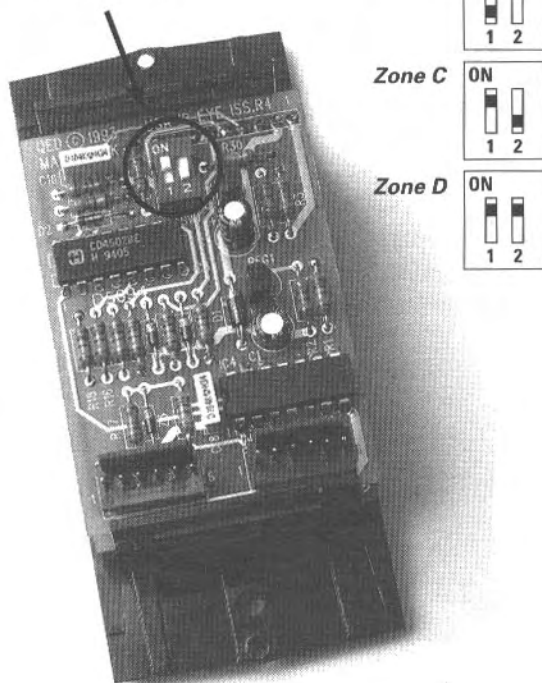

- c) Data cable terminations and connections are made the same way as previously detailed in Section 4.12 (b). Note that each RSM900 has two data terminals labeled "In" and "Out" respectively. See Section 4.3 below for zone connection strategies.

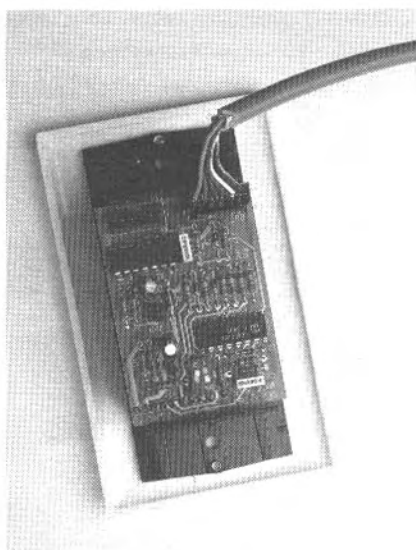

- d) Remember that an RSM900 connected to the Zone A data cable terminal **MUST** be used for initial set-up, particularly in systems where non-Rotel source components are included. Details will be found in Section 5.13.

4.22 The RKP900 Keypad

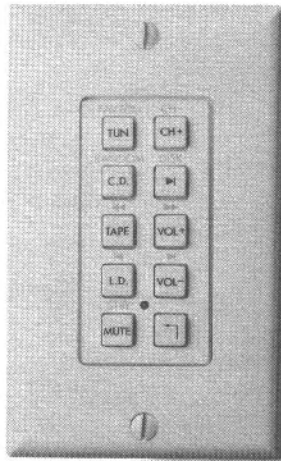

- a) The RKP900 keypad mounts in a wall box in the same manner as the RSM900 sensor/display. There are no restrictions on where the RKP900 can be located. Common sense and user convenience should be the determining factors.

Alternatively, the RKP900 can be mounted in a double-width wall box with an RSM900 sensor/display. This is the most sensible arrangement from an installation viewpoint (fewer cable runs) but may not be practical in all rooms.

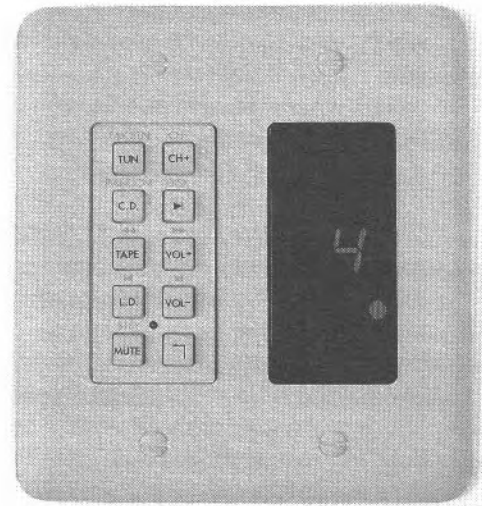

- b) RKP900s do not need to be set for particular zones as they do not display zone or system status information.
- c) Data cable terminations and connections are made the same way as previously detailed in Section 4.12 (b). As does the RSM900, each RKP900 has two data terminals ("In" and "Out") located at the bottom of its circuit board. See Section 4.3 immediately following for zone connection strategies.

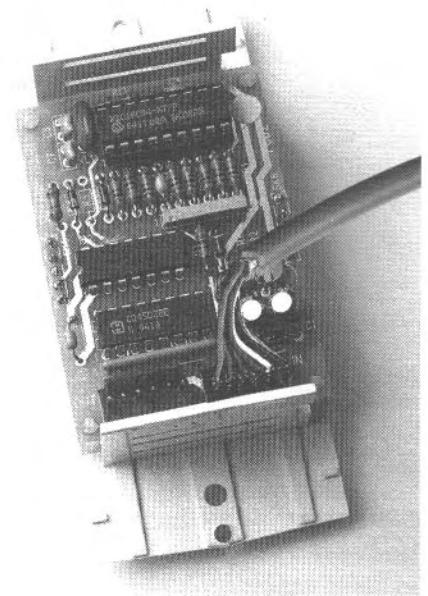

4.3 Zone Connection Strategies

- a) Each zone will support two RSM900s and two RKP900s. All the command devices for one zone should connect to each other in serial fashion using their appropriate circuit board-mounted "In" and "Out" terminals.
- b) Each RSM900 signals when it receives and processes a command. This happens regardless of whether the command was generated by a keypad or a hand held remote. However, a keypad located "downstream" of a sensor/display will *not* trigger that sensor's command processing indicator.

Whenever possible, we suggest that you configure each zone so that all keypads are "upstream" from all sensor/displays. Although not always practical depending on the zone configuration, this arrangement will reduce user confusion.

Regardless of other considerations, we suggest that you always wire an RSM/RKP double wall box so that the RSM is located "downstream" from adjacent RKP (i.e., between the RKP and the RMZ950 controller/amplifier). This assures that the sensor/display always signals the user when the adjacent keypad is used.

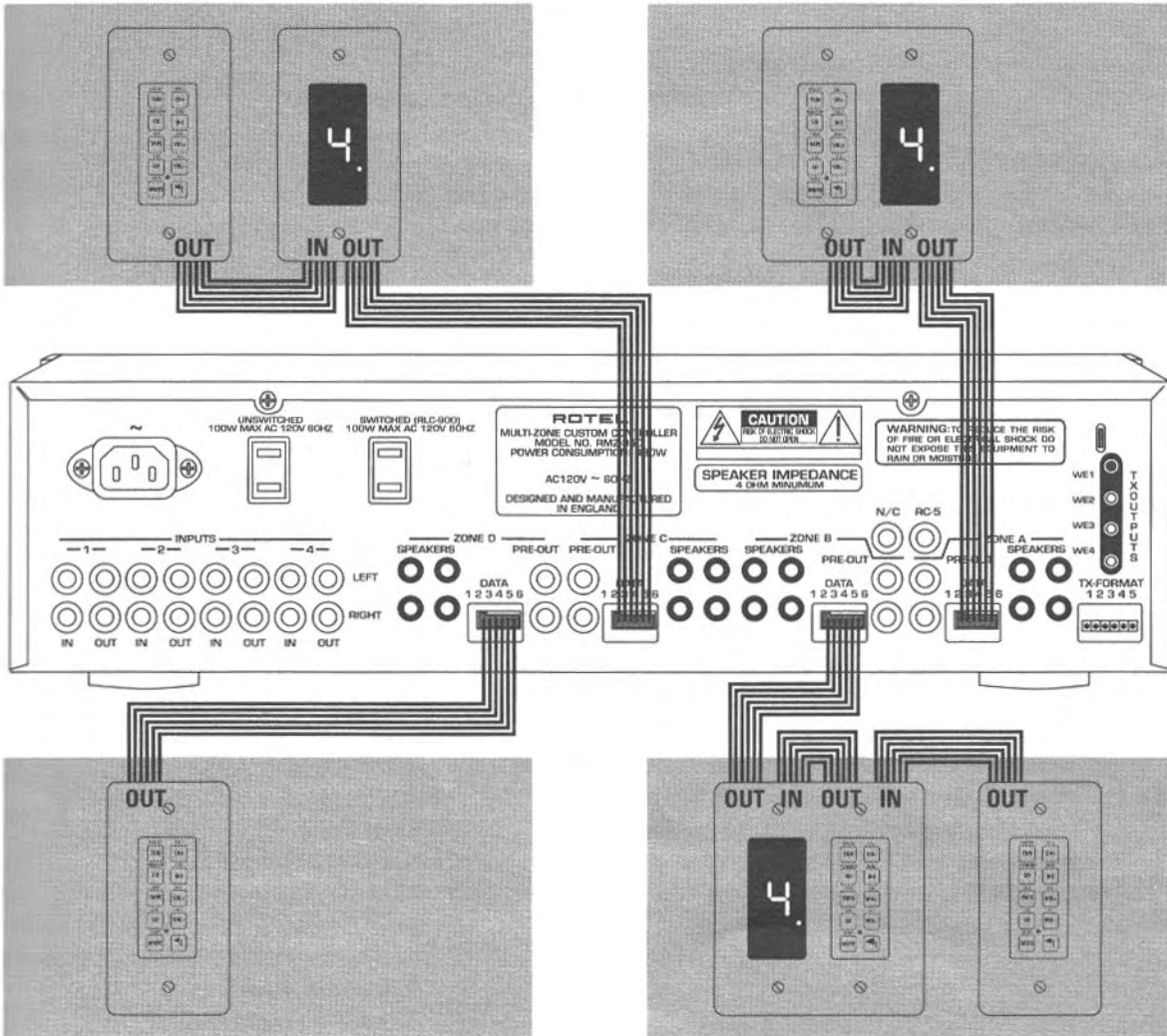

Installation is the first step towards enjoying an RMZ950 system. Proper setup ensures that the RMZ950 will function optimally with all associated source components and provide total system control.

5.1 Source Component Setup

5.11 Default operating mode

The RMZ950 is factory set for use with Rotel source components (includes both single-disc and multi-disc Rotel CD players) and Pioneer laser disc players. No adjustments are necessary for these components.

5.12 Optional operating modes

In addition to Rotel and Pioneer laser disc source components, the RMZ950 can be set to operate the following:

- Tuner:** RC-5 components
- CD:** Pioneer, RC-5 components
- Tape:** RC-5 components
- Laser disc:** RC-5 components

5.13 Setup sequence

- a) First locate Zone A's RSM900 sensor/display. Optional operating modes CANNOT be changed from any other Zone or even from Zone A's (optional) keypad.

If in doubt, send a command with the RR950 hand held remote and monitor Zone A's green Code LED on the RMZ950's front panel: it will flash when the RMZ950 recognizes and processes a command.

NOTE: Remember that any RSM900 sensor/display can be connected to the Zone A data terminal for this procedure. Even if Zone A is equipped with a wall mounted sensor/display, it is probably more convenient to temporarily disconnect the data cable from that unit and substitute another RSM900 placed near the RMZ950 and source components.

Make sure that any RSM900 used in this setup sequence has the circuit board DIP switches set for Zone A. (See Section 4.21 b) for details.)

- b) Select any input (Tuner, CD, Tape or LD) on the RR950 so that the corresponding number (1, 2, 3 or 4) shows on Zone A's RSM900 sensor/display.
- c) Place the Setup Card over the RR950's pushbuttons.



- d) With the RR950 pointing at the RSM900 sensor/display, enter "Setup" mode by pushing both Setup buttons. To do so, depress the left-hand Setup button and hold it. Then push the right hand Setup button. The RSM900 will display a "?" to indicate that the system is awaiting further instructions.
- e) Push the desired command code button beside each input you want to change. (DO NOT push the input selector button itself.) Zone A's RSM900 will display the following characters to indicate your choice of custom command configurations:

- A - RC-5 tuner**
- B - Rotel tuner**
- C - Pioneer CD player**
- D - RC-5 CD player**
- E - Rotel CD player (see following note)**
- F - RC-5 tape deck (all except DCC decks)**
- G - Rotel tape deck**
- H - Pioneer laser disc player**
- J - RC-5 laser disc player**

NOTE: Rotel CD players operate with the following control codes:

RCD940BX	⇒	"Rotel" code
RCC940AX	⇒	"Rotel" code
RCD970BX	⇒	"RC-5" code
RCD975BX	⇒	"RC-5" code

The factory-default setting for CD operation is the "Rotel" code. If you are using an RCD970/975BX, change the CD code setting to "RC-5".

After you've selected the proper command codes for all the component categories you wish to change, exit "Setup" by holding the left hand Setup button, pushing the right hand Setup button and immediately releasing both Setup buttons.

The RSM900's "STBY" indicator bar (" _ ") will flash twice to signal that the system has stored chosen command codes, exited the Setup mode and is now operating normally.

NOTE: See Section 5.33 below for further details on the "Power Toggle" command required when the RMZ950 system (and associated source components) use the highly recommended RLC900 Power Line Conditioner as an AC power source.

All changes are stored in non-volatile memory and can not be accidentally erased, even by unplugging the RMZ950. The only way to change command code operation is to access Setup mode again.

For example, if you want to configure the system to operate with a Pioneer CD player and a Marantz laser disc player, simply:

Enter Setup mode ("?" will show on the RSM900).

Push the button marked "Pioneer" to the right of the CD input selector ("C" will show on the RSM900).

- c) Push the button marked "RC-5" to the right of the L.D. input selector ("J" will show on the RSM900).
- d) Exit Setup mode (" _ " will flash twice on the RSM900).

5.2 IR System and Control Codes

5.21 OVERVIEW

The RMZ950's IR system provides extensive remote control flexibility. With the possible exception of the points in Sections 5.22 and 5.23 below, nothing needs to be done to set up the IR system.

However, please note the following points:

- a) The IR link from a remote zone operates ONLY when that zone is active.
- b) The IR codes generated by the RR950 hand held remote are RMZ950 "system specific" codes and ARE NOT the same codes generated by a source component controller, even for functions that appear identical such as "CD play," for example. In other words, you can not use the RR950 to directly control a Rotel CD player but must use it through an RSM900 sensor/display from a remote zone. The RMZ950 system does the following:
 - A wall mounted RSM900 sensor/display receives the remote's code sequence and translates it into proprietary 5 bit digital code.
 - This digital code travels over the data cable to the RMZ950 controller/amplifier.
 - The RMZ950's translator card restores the code's original configuration (when required) and sends it to both the IR "flood" emitter and the rear panel IR outputs for use by the appropriate source component.

- c) In addition to passing RMZ950 system codes, the IR system will pass ALMOST any IR code sequence from an RSM900 to a source component. (These few exceptions use a non-standard IR transmission frequency.) This allows you to control transport functions of a VCR from a remote zone, for example, with the VCR's dedicated hand held remote.

5.22 Front Panel IR Flood Emitter

All RMZ950s are shipped with the front panel IR "flood" emitter engaged. However, there may be applications (system installations on open shelves in very large, bright rooms, for example) where the IR "flood" emitter might interfere with proper source component operation or will not be particularly effective in communicating control pulses.

To disable the IR "flood" emitter, remove the jumper wire between screws 2 and 3 of the TX FORM terminal block located on the lower right hand side of the RMZ950's rear panel.

NOTE: *There is a very low intensity red LED mounted behind the emitter's window which flashes whenever it is transmitting IR codes. Use this LED to verify the emitter's operating status.*

Optional remote IR emitters for use in lieu of front panel IR flood emitter.

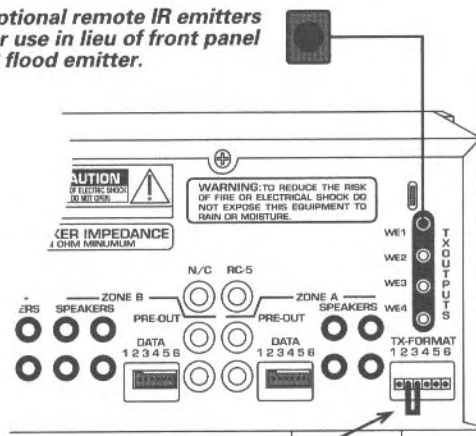

Remove this jumper to disable front panel IR flood emitter.

5.23 Rear Panel IR Emitters

The RMZ950 rear panel has four parallel 3.5mm mini-plug sockets labeled "INFRA RED." They accept standard "stick on" IR repeaters like Xantech's Video Link 282-00.

Use these optional repeaters in situations where the RMZ950 will be located some distance away from the source components or where the IR "flood" emitter may have difficulty transmitting reliable source control data.

5.3 AC Line Considerations

5.31 AC for the RMZ950

Plug the RMZ950 controller/amplifier into an **unswitched** AC source only. We recommend a powerline filter as the RMZ950 system contains a number of microprocessor ICs that may benefit from the extra protection afforded by a quality filter/surge protector.

5.32 AC for Source Components

The RMZ950 has two rear panel AC convenience outlets, one switched and the other unswitched. These may be used to supply power for components used with the RMZ950. Each outlet carries a maximum load rating of 100 watts.

- a) Unswitched AC convenience outlet: The RMZ950's Unswitched AC outlet supplies AC current whenever the RMZ950 is plugged into a live AC source. This outlet is NOT controlled by the setting of the RMZ950's front panel power switch.
- b) Switched AC convenience outlet: When the RMZ950's front panel switch is Off, the switched AC outlet is also off. Even when the front panel switch is turned On (i.e., when the RMZ950 first powers up to "Standby" mode), the switched outlet remains off until the RMZ950 receives a zone activation command.

The switched AC outlet then remains on until the front panel power switch is turned Off or the RMZ950 receives a "system shutdown" command from a remote zone. (See Section 6 for details.)

If you choose to power source components from the RMZ950's Switched AC outlet and your system includes a Rotel tuner or a Pioneer Laser Disc player or both, ACTIVATE the RMZ950's software-based "Power Toggle" command.

To do so, enter Setup Mode from Zone A (see Section 5.13 above for details) and press the RLC900 "Y" (for Yes) key and then exit Setup. This activates the RMZ950's software-based "Power Toggle" command. (See Section 5.34 below for additional notes on the "Power Toggle" command.)

If source components are powered directly from an AC wall outlet, make sure the "Power Toggle" command is DEACTIVATED (the RMZ950's default condition) and that any source components featuring a "Standby" mode are "ON" before using the RMZ950.

5.33 AC Power Recommendations

NOTE: Although the information contained here is more properly a subset of 5.32 b) above, we have moved it to a separate section for emphasis.

We strongly recommend that all RMZ950 systems use the RLC900 AC line conditioner/switcher to improve both the performance and convenient operation of all system components. The RLC900's major benefits include increased protection from AC power line surges and improved system AC power management for proper turn-on and turn-off sequences.

To incorporate the RLC900, follow these steps:

Plug all system source components into the RLC900's "Digital Equipment" or "Accessories" outlets as appropriate.

Plug the RMZ950's AC power cord into the RLC900's "UNSWITCHED" outlet. (This is the right hand outlet on the

RLC900's rear panel.)

- c) Plug the RLC900's "Control Cord" into the RMZ950's SWITCHED outlet.
- d) Plug the RLC900's "Main Power" cord into an unswitched AC outlet such as a wall receptacle, etc.

5.34 "Power Toggle" Command

The "Power Toggle" command, which operates only on Pioneer laser disc players and the Rotel RT940AX tuner, fully activates these components even though they usually go into a quiescent or Standby mode when first plugged into the wall or when AC power becomes available after they've been turned Off.

To understand this fully, remember that "Off" is a relative term with remote controlled components. They may be "off" as in totally disconnected from AC power or "off" as in using only very small amounts of AC power to keep low level circuitry functioning (front panel IR sensors and a microprocessor or two, for example) so that the entire component may be activated with a remote command.

Source components connected through the RLC900 are "Off" — totally disconnected from AC — when the RLC900's "Digital Equipment" and "Accessories" outlets are switched off. Consequently, when the RMZ950/RLC900 combination first activates the source components, some go into a "standby" mode where a few sensors and microprocessors are powered but where major circuitry blocks are still inactive. The "Power Toggle" command tells the sensors and microprocessors to "wake up" the rest of the component.

The following steps will illustrate how the "Power Toggle" command works:

- RMZ950 in "Standby" mode, source components OFF.
- Zone activation command received. RMZ950 ON, Switched AC outlet activated, RLC900 accessory outlets switched ON, Source components switched ON or to "Standby" mode.

- RMZ950 sends "Power Toggle" command to Rotel tuner and Pioneer laser disc player. "Power Toggle" triggers change from "Standby" to fully ON.
- All source components ready for remote zone use.

Remember that the "Power Toggle" command default is OFF but it can be easily activated by following the instructions in Section 5.32 b).

RMZ950 "A" to the corresponding Source 1 inputs on RMZ950 "B". Follow this procedure for all inputs.

5.4 Advanced Multi-Zone Systems

5.41 Eight & Twelve Zone Systems

The RMZ950 is designed to supply independently controlled sound to four separate zones. In rare instances, a complex system may require even more flexibility. To satisfy these requirements, up to three RMZ950s can be cascaded to form a system with as many as 12 independent zones. Under these circumstances, all RMZ950 controller/amplifiers can still use only one set of source components.

5.42 Large System Configuration

When system complexity calls for more than one RMZ950, we have no cautions about stacking controller/amplifiers on top of each other. As long as there is sufficient room to allow relatively unrestricted air flow, heat should not be a problem.

All hookup instructions will assume that Zones 1-4 will be handled by the bottom RMZ950 (called "A"), Zones 5-8 from the RMZ950 immediately above it ("B") and Zones 9-12 by the top unit ("C").

5.43 Source Connections

Connect all sources to the first RMZ950 ("A") per the instructions in Section 4.11. Using shielded RCA-RCA cables, connect Source 1's "loop through" outputs on

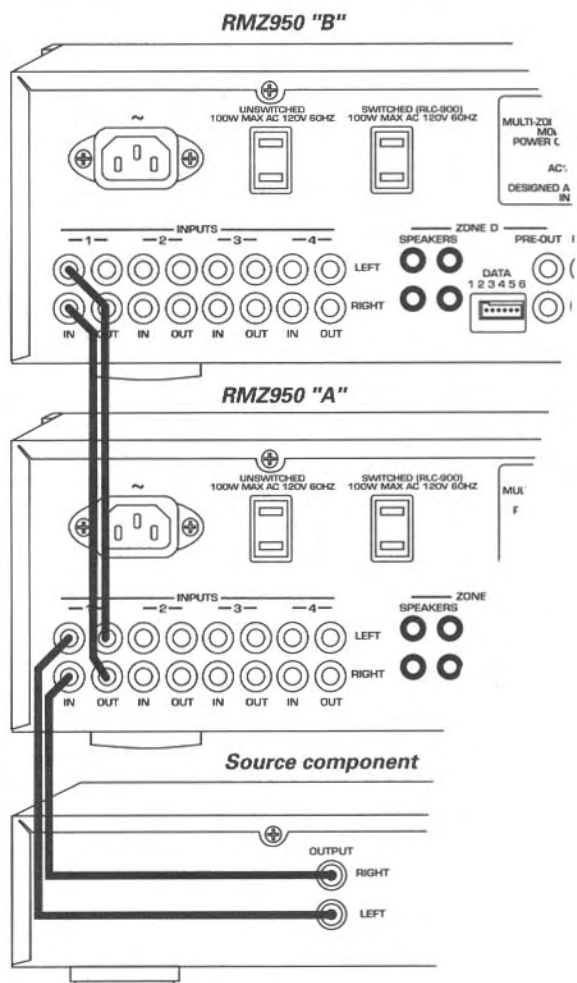

If a system requires a third RMZ950, simply repeat this procedure but, this time, connect source output on RMZ950 "B" to the corresponding input on RMZ950 "C".

NOTE: It is doubly (or trebly) important to observe proper channel continuity when connecting source components to more than one RMZ950. Once again, BE PATIENT AND BE CAREFUL.

5.44 IR Flood Emitter Connections

When 2 or 3 RMZ950s are used in the same system, we suggest that you connect them so that only one IR "flood" emitter works. This avoids potential interference that may lead to erratic operation.

Note that this is a suggestion only and not a hard and fast rule. There may be some system layouts which benefit from the increased signal strength from all IR "flood" emitters. Experiment as needed. Use the following connection guide for multiple RMZ950 systems:

- a) For 5-8 zone systems (2 RMZ950s):
- Remove the jumper between terminals 2 and 3 of the TX FORM block on RMZ950 "A" but leave the jumper in place on RMZ950 "B".
 - Connect terminal 3 of RMZ950 A's TX FORM block to terminal 4 on RMZ950 "B".

This completes the signal link to the IR "flood" emitter on RMZ950 "B".

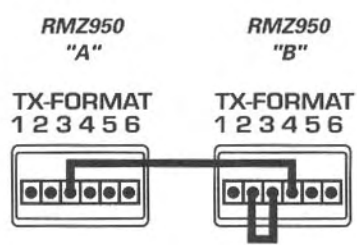

Use this jumper arrangement in a system with 2 RMZ950 controllers to disable the flood IR emitters on the first controller and enable the emitter on the second.

- To activate BOTH IR "flood" emitters, connect terminal 2 on RMZ950 "B" to terminal 2 on RMZ950 "A".

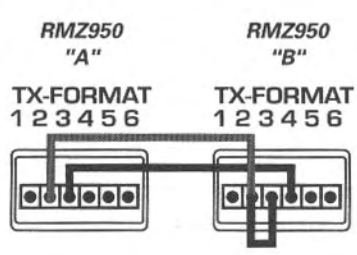

Use this jumper arrangement in a system with 2 RMZ950 controllers to enable the flood IR emitters on both RMZ950 controllers.

NOTE: To disable both IR "flood" emitters, simply remove the jumper between terminals 2 and 3 of RMZ950 "B". Also disconnect any link between terminal 2 of both "A" and "B".

- b) For 9-12 zone systems (3 RMZ950s):
- Remove the jumpers between terminals 2 and 3 of the bottom two RMZ950's TX FORM blocks (RMZ950 "A" and "B") but leave the jumper in place on RMZ950 "C".
 - Connect terminal 3 of the RMZ950 "A" TX FORM block to terminal 4 on RMZ950 "B".
 - Connect terminal 3 of the RMZ950 "B" TX FORM block to terminal 4 on RMZ950 "C".

This completes the signal link to the IR "flood" emitter on RMZ950 "C".

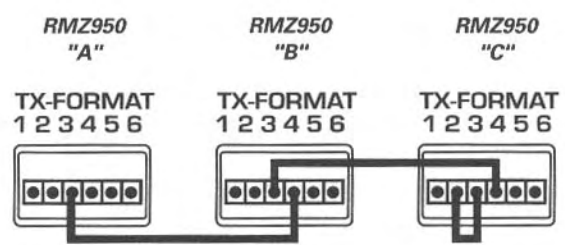

Use this jumper arrangement in a system with 3 RMZ950 controllers to disable the flood IR emitters on the first two controllers and enable the emitter on the third.

- To activate ALL IR "flood" emitters, connect terminal 2 on RMZ950 "C" to terminal 2 on RMZ950 "B". Then connect terminal 2 on RMZ950 "B" to terminal 2 on RMZ950 "A".

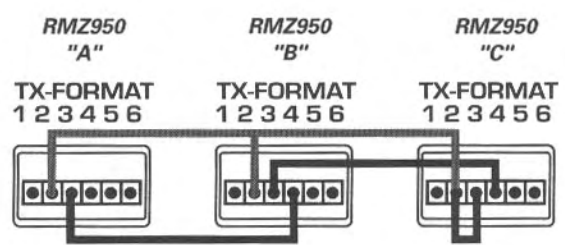

Use this jumper arrangement in a system with 3 RMZ950 controllers to activate the flood IR emitters on all three RMZ950 controllers.

NOTE: To disable all IR “flood” emitters, simply remove the jumper between terminals 2 and 3 of RMZ950 “C”. Also disconnect any link between terminal 2 of “A” and “B” and “C”.

5.45 IR Repeater Connections

Use the following connection guide for multiple RMZ950 systems:

- a) For 5-8 zone systems (2 RMZ950s): Make sure to connect all IR repeaters to only RMZ950 “B”. Make all RC-5 connections, if needed, to only RMZ950 “B”.
- b) For 9-12 zone systems (3 RMZ950s): Make sure to connect all IR repeaters to only RMZ950 “C”. Make all RC-5 connections, if needed, to only RMZ950 “C”.

5.46 AC Connections

In systems using multiple RMZ950s, determine which RMZ950 will control “prime” zones. Connect THAT RMZ950 to the recommended RLC900 per the instructions in 5.33 above. Plug the other RMZ950(s) to the “For Power Amp” socket(s) on the RLC900’s rear panel.

We suggest that the “last” RMZ950 in a chain, either “B” or “C,” be designated as the controller/amplifier for prime zones as this RMZ950 will have all IR repeaters and the RC-5 control cable (if needed) plugged into it.

NOTE: Once the system is hooked up this way, system shutdown and power-up commands can be issued **ONLY** from zones connected to the “prime” RMZ950.

As with a system using a single RMZ950, the initial power-up sequence will take about 7-9 seconds for sources. The prime RMZ950 will power up immediately but non-prime RMZ950(s) will need about 10-12 seconds to reach full operating status as the RLC900 delays switching on these units immediately to prevent large AC power surges from tripping circuit breakers or fuses.

SUGGESTION: Select “Tuner” when initially powering the system. This will give you a quick and relatively foolproof sta-

tus check. If you want another source, simply choose it after you hear output from the tuner.

5.47 “Power Toggle” Set-up

If the system uses the “prime” RMZ950’s switched outlet/RLC900 combination, **make sure that the “Power Toggle” command is DISENGAGED in the other RMZ950(s).** Even though the default “Power Toggle” setting is Off, verify that this has not changed by temporarily connecting an RSM900 to the Zone A data terminal of each remaining RMZ950, entering Setup Mode as outlined in Section 5.32 (b) and pressing the RLC900 “n” (for No) key. Then exit Setup.

This is a critical step in a system using multiple RMZ950s. If the “Power Toggle” is not deactivated in the non-prime RMZ950(s), source components will not turn on and off with the controller/amplifiers — in fact, source components may actually turn off when RMZ950s turn on.

5.48 Note on “Engaged” Indicator

The “Engaged” indicator on a remote zone’s RSM900 sensor/display(s) will indicate other same-source users only in zones connected to that particular RMZ950 controller/amplifier.

For example, in an 8-zone system using two RMZ950s, a CD listener in Zone 7 (connected to the second RMZ950) would have no indication that another user in Zone 2 (connected to the first RMZ950) was listening to the same source. If a third listener in Zone 4 then selected CD, only the listeners in Zones 2 and 4 (both connected to the same RMZ950) would know that someone else was sharing the same source.

6.1 Preliminary Observations

Once properly installed and set up, the RMZ950 Multi-Room Control System is exceptionally easy to operate.

As detailed in Section 5.31, the RMZ950 controller/amplifier should ALWAYS be plugged into an uninterruptable AC source. This ensures that essential RMZ950 system benefits such as remote controlled zone activation and source selection are always available.

Zone control devices (the RKP900 keypad and RSM900 sensor display) are powered from the data cables and are always active as long as the RMZ950 is connected to AC.

6.2 RR950 Hand-held Remote Control

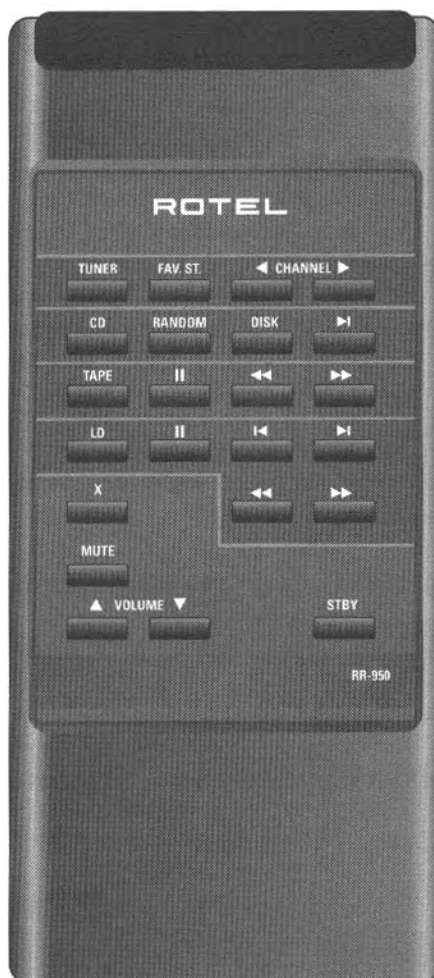

The RR950 controller provides easy and convenient system operation from any zone equipped with a RSM900 sensor/display. You will find that the RR950/RSM900's operating range is longer and the angle of acceptance is wider than with many other hand held controllers. This increased operating convenience is a direct result of a more powerful transmitter in the remote and more sensitive receiving circuitry in the sensor/displays. Enjoy the difference.

6.21 Input Selector Buttons

Depending on system status, pressing any of these buttons will do one of the following:

- a) If the entire system is "Off" (i.e., the RMZ950 controller/amplifier is in "Standby" mode and all source components are either Off or in "Standby"), pressing any input selector button will activate the entire system (including source components) for distribution as requested.
- b) If only the requesting zone is in "Standby" (and the rest of the system, including sources, is active), selecting an input will enable that zone's microprocessor-controlled switching circuitry and direct that source's output to the requesting zone. If the requested source is not already in use by another zone, selecting the source will also engage Play mode.
- c) If the requesting zone is already playing a different source, pushing another input selector button will simply choose the new source.
- d) Input selector buttons for CD, TAPE and LD double as "Play" command buttons for their respective sources. This is important when a source is in "Pause" mode: Simply press the proper input selector again to resume play.

6.22 Tuner control buttons

- a) **FAV STN (Favorite Station):** This will select the first station (Preset #1) programmed into the tuner's memory.
- b) **◀ CHANNEL:** This selects the next PRE-PROGRAMMED station LOWER in frequency than the one playing.
- c) **CHANNEL ▶ :** This selects the next PRE-PROGRAMMED station HIGHER in frequency than the one playing.

NOTE: As mentioned in b) and c) above, BOTH ◀ CHANNEL AND CHANNEL ▶ BUTTONS SELECT PRE-PROGRAMMED STATIONS ONLY. For example, consider a tuner with FM presets at 98.1 MHz, 98.9 MHz and 99.5 MHz. If you are listening to

98.9 and you choose the ◀ CHANNEL pushbutton, you will hear 98.1 MHz broadcast next even though there may be a very strong and listenable station at 98.5 MHz.

6.23 CD control buttons

- a) **RANDOM:** This instructs the CD player to play discs and cuts in whatever random order the CD player chooses.
- b) **DISK** (functional only with multi-play CD players): This advances the CD player to the next available disc.
- c) **▶ :** This advances the CD player to the next track on the disc being played.

6.24 Tape control buttons

- a) **|| (Pause):** This button momentarily stops tape travel until the Tape input selector is pushed again. (Caution: do not leave tape decks in pause mode for more than 2 or 3 minutes as this will damage capstans and pinch rollers.)
- b) **◀◀ (Rewind):** This rewinds the tape. Press the TAPE input select pushbutton to put the deck back into PLAY mode again.
- c) **▶▶ (Fast forward):** Same as b) above but in the opposite direction.

6.25 Laser Disc control buttons

- a) **|| (Pause):** This button momentarily stops disc play until it is pushed again.
- b) **◀ (Last track/chapter):** If a track/chapter is being played, this button backs the video disc player to the beginning of that track and continues playing. Two quick pushes backs the player to the beginning of the PREVIOUS track or chapter.
- c) **▶ (Next track/chapter):** If a track/chapter is being played, this button advances the video disc player to the beginning of the next track/chapter and continues playing. Two quick pushes advances play two tracks/chapters and so on.

d) **◀◀ (Reverse Scan)**: This begins a high speed reverse scan useful for returning to a desired point in a movie, etc. Press the LD input selector button to go back to Play mode when you've reached the desired point on the disc.

e) **▶▶ (Forward Scan)**: The same as d) above but in the opposite (i.e., forward) direction.

6.26 MUTE

This temporarily reduces zone volume to very quiet levels for telephone conversations, etc. Press Mute again to restore original volume settings. You can also press Volume Up, Volume Down or any Input button to restore original levels.

6.27 VOLUME UP/VOLUME DOWN

No hidden information here - simply press the appropriate button to increase or decrease playback levels as desired.

6.28 STBY

This button has two functions:

- A brief push will put the Zone from which the command originated into Standby status. All other zones will remain unaffected. Source components will remain on.
- A continuous push (more than 3.5 seconds) will have one of the following effects depending on system configuration:
 - In a system using only one RMZ950, a continuous push of more than 3.5 seconds will power down the entire system including source components.
 - In a system using multiple RMZ950s, a continuous push of more than 3.5 seconds FROM A PRIME ZONE (i.e., a zone directly connected to the prime RMZ950) will power down the entire system. The prime RMZ950 will go into Standby mode. All source components and supplementary RMZ950(s) connected to an RLC900 will shut off completely.
 - In a system using multiple RMZ950s, a continuous push of more than 3.5 seconds FROM A NON PRIME ZONE (i.e., a

zone directly connected to other RMZ950s) will put the RMZ950 connected to that zone into Standby mode. All zones connected to that RMZ950 will shut down until an input selector from one of those zones is pushed. Other RMZ950s will be unaffected.

However, a continuous (> 3.5 seconds) push of the STBY button from any zone will generate a STOP COMMAND TO ALL SOURCE COMPONENTS EXCEPT THE TUNER.

6.29 "X"

This is reserved for future use and inoperative at the present time.

6.3 RKP900 Keypad

The RKP900 keypad offers easy access to most RMZ950 system functions. It includes 10 individual keys and an LED indicator to aid in sending the proper commands to the controller/amplifier. The major functional difference between the RKP900 keypad and RR950 hand held remote controller is that the wall-mounted keypad has only ten keys.

6.31 "Obvious" key functions

Most keys have a dual purpose. Used alone, they control dedicated functions marked on the key surfaces.

6.32 "Hidden" key functions

Used in conjunction with the SHIFT key, the same keys also control different ("hidden") functions as indicated by the less obtrusive IDs on the protective plate surrounding the keys.

Access these "hidden" commands by first pressing SHIFT and then an appropriate key. When you press SHIFT, the red LED at the bottom center of the keypad will glow to indicate that you are asking for a "hidden" command. The LED will go out as soon as you press another key.

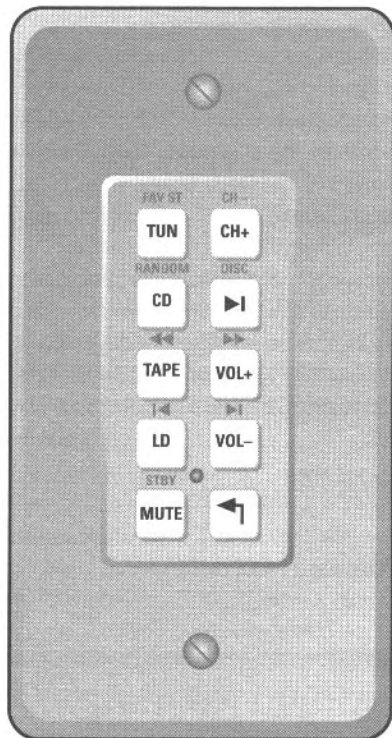

primary functions shown on keys

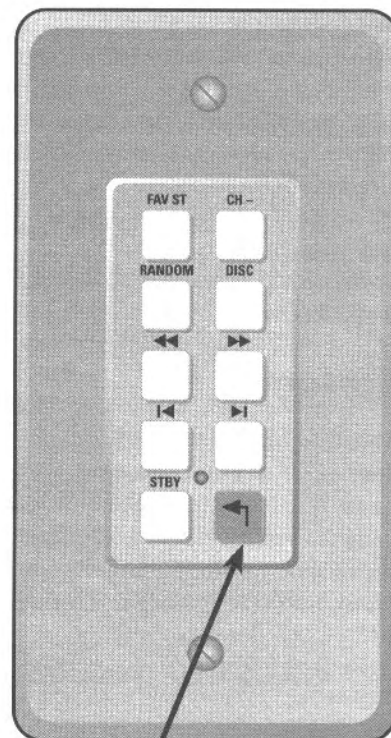

press SHIFT key to access "hidden" functions

6.33 TUNER commands

- a) **TUN:** This chooses the tuner as a zone input. (We recommend this choice as the ideal way to activate the RMZ950 and source components after a power-down command.)
- b) **CH+:** Push this to advance to the next PRE-PROGRAMMED station. (For example, if you are listening to preset #5, this key will select preset #6.)
- c) **FAV STN (SHIFT → TUN):** This key sequence will recall the broadcast frequency stored in the tuner's first pre-programmed memory slot.
- d) **CH- (SHIFT → CH+):** This sequence will select the lowest PRE-PROGRAMMED station. (For example, if you are listening to preset #5, this key sequence will select preset #4.)

6.34 CD commands

- a) **CD:** This chooses the CD player as a zone input and activates the CD player's "play" command if needed.
- b) **▶|:** This advances the CD player to the CD's next track.
- c) **RANDOM (SHIFT → CD):** This activates the CD player's "random" playback mode.
- d) **DISK (SHIFT → ▶|):** This advances a multi-disc CD player to the next available disc.

6.35 TAPE commands

- a) **TAPE:** This chooses the tape deck as a zone input and activates the deck's "play" command if needed.
- b) **▶▶ (SHIFT → TAPE):** This begins high speed REWIND mode. Stop and begin play at any point by pressing TAPE.

- c) **◀◀ (SHIFT → VOL+)**: This begins high speed FAST FORWARD mode. Stop and begin play at any point by pressing TAPE.

6.36 LASER DISC commands

- a) **LD**: This chooses the laser disc player as a zone input and activates the player's "play" command if needed.
- b) **◀ (SHIFT → LD)**: If a track/chapter is being played, this key backs the video disc player to the beginning of that track and continues playing. Two quick pushes backs the player to the beginning of the PREVIOUS track or chapter.
- c) **▶ (SHIFT → VOL-)**: If a track/chapter is being played, this button advances the video disc player to the beginning of the next track/chapter and continues playing. Two quick pushes advances play two tracks/chapters and so on.

6.37 SYSTEM commands

- a) **VOL+**: Just as you expect: press to increase volume.
- b) **VOL-**: The same but in the opposite direction.
- c) **MUTE**: Temporarily reduces system volume to almost full attenuation. Restore preselected volume levels by pressing MUTE again, VOL+, VOL- or any input selector.
- d) **STBY or "Standby" (SHIFT → "brief push" MUTE)**: This deactivates only the zone which generated the command. All other system elements, including source components, remain active.

NOTE: Activate "Zone Standby" by pressing SHIFT followed by a brief push on MUTE.

- e) **SYSTEM SHUT-DOWN (SHIFT → MUTE for more than 3.5 seconds)**: This will shut down the entire system including source components.

NOTE: In a system using multiple RMZ950s, this command will deactivate the entire system only if the command

originates from a zone connected to the prime RMZ950. (See Section 5.46 for details.) Otherwise, this command will put ONLY the RMZ950 connected to the that zone into Standby mode and will deactivate other zones connected to the same RMZ950.

However, note that the SYSTEM SHUT-DOWN command includes an embedded STOP command for all system source components except the tuner. This means that these sources will stop, even if they are being used by zones controlled by another RMZ950.

6.4 RSM900 Sensor/Display

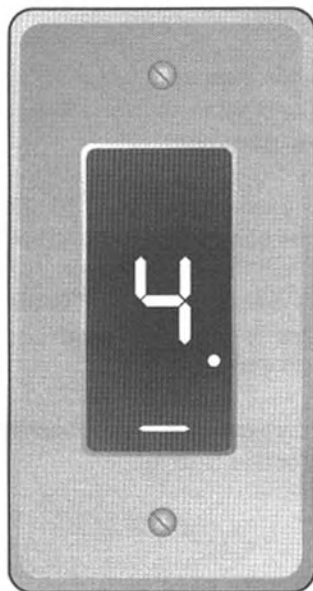

6.41 Overview

The RSM900 sensor/display receives IR signals from the RR900 hand held controller and other IR devices. In addition, it provides feedback on system status through an LED display matrix mounted behind the cover plate.

The LED display supplies the following data:

- a) **System status**: The Standby bar ("—" located at the bottom of the display area) indicates that a zone is temporarily deactivated even though the RMZ950 controlling that zone is operating.

If there is no Standby bar showing and no source is currently playing in a zone, that zone's RMZ950 is deactivated. In a single RMZ950 system, simply press any input selector (preferably TUN) to activate the RMZ950 and the zone. In a multiple RMZ950 system, you may need to activate all components by selecting a source from a prime zone. (See Section 5.46 for details.)

In a single RMZ950 system, the Standby bar will flash twice to indicate a complete system "power down." In a multiple RMZ950 system, only the Standby bars in zones connected directly to the prime RMZ950 will flash twice. Sensor/displays connected to other RMZ950s will simply go out. (Note that it is impossible to turn the entire system "Off" from a non-prime zone.)

- b) Source selection: The numbers 1, 2, 3 or 4 indicate what source is selected for that particular zone.
- c) The Engaged indicator (•) shows if other zones connected to the same RMZ950 are sharing the same source. This is a courtesy measure designed to alert users not to capriciously change stations or tracks while sharing a source.
- d) Other system set up indicators as detailed in Section 5.13 (e).

7.0 Conclusion

We hope this manual has been of assistance in planning and installing your multi-room sound distribution system. Although we've gone to great lengths to make this as complete as possible, we're sure we haven't covered every aspect of every possible system installation. Please feel free to call our Technical Service department if you have any questions. Thank you very much.

Rotel of America, Inc.
54 Concord Street
North Reading, MA 01864-2699
(800) 370-3741
(508) 664-4109 (FAX)

© 1995 Rotel of America
All Rights Reserved
Written by TechniCom
Printed in Canada