

ROTEL[®]

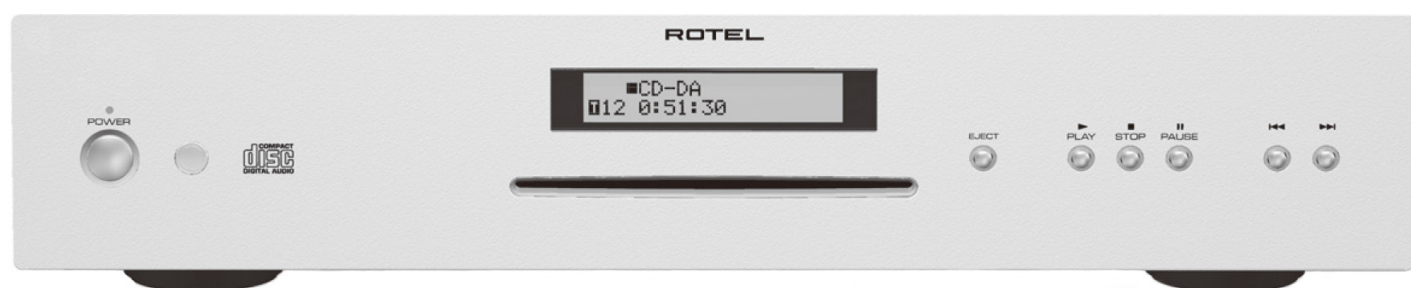

RCD-630

Stereo Compact Disc Player

立体声CD播放机

Owner's Manual
使用说明书



CAUTION

RISK OF ELECTRIC SHOCK
DO NOT OPEN



WARNING : SHOCK HAZARD-DO NOT OPEN
AVIS: RISQUE DE CHOC ÉLECTRIQUE-NE PAS OUVRIR



This symbol is to alert the user to the presence of uninsulated dangerous voltages inside the product's enclosure that may constitute a risk of electric shock.



This symbol is to alert the user to important operating and maintenance (service) instructions in this manual and literature accompanying the product.

APPLICABLE FOR USA, CANADA OR WHERE APPROVED FOR THE USAGE

CAUTION: TO PREVENT ELECTRIC SHOCK, MATCH WIDE BLADE OF PLUG TO WIDE SLOT. INSERT FULLY.

ATTENTION: POUR EVITER LES CHOCS ELECTRIQUES, INTRODUIRE LA LAME LA PLUS LARGE DE LA FICHE DANS LA BORNE CORRESPONDANTE DE LA PRISE ET POUSSER JUSQU'AU FOND.

This Class B digital apparatus complies with Canadian ICES-003.

Cet appareil numérique de la classe B est conforme à la norme NMB-003 du Canada.

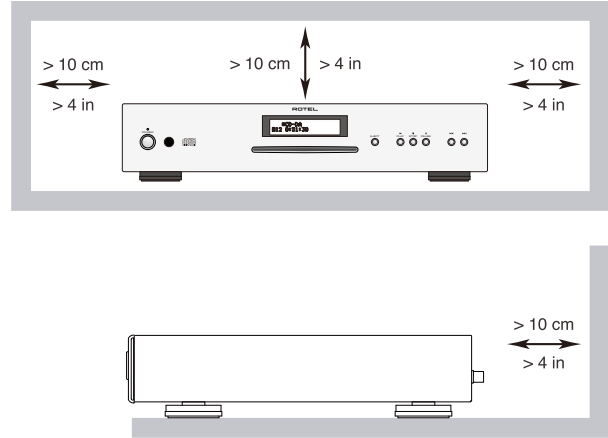

**CLASS 1
LASER PRODUCT**

IMPORTANT FOR LASER PRODUCT

1. CLASS 1 LASER PRODUCT
2. **DANGER:** Visible laser radiation when open and interlock failed or bypassed. Avoid direct exposure to beam.
3. **CAUTION:** Do not open the top cover. There are no user serviceable parts inside the player; leave all servicing to qualified service personnel.

WARNING!

To reduce the risk of electrical shock, fires, etc.:

1. Do not remove screws, covers or cabinet.
2. Do not expose the unit to rain or moisture.
3. Do not touch the power cord or plug with wet hands.



Rotel products are designed to comply with international directives on the Restriction of Hazardous Substances (RoHS) in electrical and electronic equipment and the disposal of Waste Electrical and Electronic Equipment (WEEE). The crossed wheeled bin symbol indicates compliance and that the products must be appropriately recycled or processed in accordance with these directives.



This symbol means that this unit is double insulated. An earth connection is not required.

Notice

The rear mini USB connection should be handled by authorized persons only.

FCC Information

This equipment has been tested and found to comply with the limits for a Class B digital device, pursuant to Part 15 of the FCC Rules. These limits are designed to provide reasonable protection against harmful interference in a residential installation. This equipment generates, uses and can radiate radio frequency energy and, if not installed and used in accordance with the instruction, may cause harmful interference to radio communications.

However, there is no guarantee that interference will not occur in a particular installation. If this equipment does cause harmful interference to radio or television reception, which can be determined by turning the equipment off and on, the user is encouraged to try to correct the interference by one or more of the following measures:

- Reorient or relocate the receiving antenna.(TV, radio, etc.)
- Increase the separation between the equipment and receiver.
- Connect the equipment to an outlet on circuit different from that to which the receiver is connected.
- Consult the dealer or an experienced radio/TV technician for additional help.

Caution

This device complies with part 15 of the FCC Rules. Operation is subject to the following conditions: (1) This device may not cause harmful interference, and (2) this device must accept any interference received, including interference that may cause undesired operation.

NOTE TO CATV SYSTEM INSTALLER: Call the CATV system or antenna installer's attention to Article 820-40 of the NEC. This provides guidelines for proper grounding and, in particular, specifies that the cable ground shall be connected to the grounding system of the building, as close to the point of cable entry as practical. See installation diagram.

Important Safety Instructions

WARNING: There are no user serviceable parts inside. Refer all servicing to qualified service personnel.

WARNING: To reduce the risk of fire or electric shock, do not expose the unit to moisture or water. Do not expose the unit to dripping or splashing. Do not place objects filled with liquids, such as vases, on the unit. Do not allow foreign objects to get into the enclosure. If the unit is exposed to moisture, or a foreign object gets into the enclosure, immediately disconnect the power cord from the wall. Take the unit to a qualified service person for inspection and necessary repairs.

Read these instructions.

Keep these instructions.

Heed all warnings.

Follow all instructions.

Do not use this apparatus near water.

Clean only with dry cloth.

Do not block any ventilation openings. Install in accordance with the manufacturer's instructions.

Do not install near any heat sources such as radiators, heat registers, stoves, or other apparatus (including amplifiers) that produce heat.

Do not defeat the safety purpose of the polarized or grounding-type plug. A polarized plug has two blades with one wider than the other. A grounding type plug has two blades and a third grounding prong. The wide blade or the third prong are provided for your safety. If the provided plug does not fit into your outlet, consult an electrician for replacement of the obsolete outlet.

Protect the power cord from being walked on or pinched particularly at plugs, convenience receptacles, and the point where they exit from the apparatus.

Only use attachments/accessories specified by the manufacturer.

Use only with the cart, stand, tripod, bracket, or table specified by the manufacturer, or sold with the apparatus. When a cart is used, use caution when moving the cart/apparatus combination to avoid injury from tip-over.



Unplug this apparatus during lightning storms or when unused for long periods of time.

Refer all servicing to qualified service personnel. Servicing is required when the apparatus has been damaged in any way, such as power-supply cord or plug is damaged, liquid has been spilled or objects have fallen into the apparatus, the apparatus has been exposed to rain or moisture, does not operate normally, or has been dropped.

The apparatus should be used in non tropical climate.

You must allow a minimum 10 cm or 4 inches of unobstructed clearance around the unit.

WARNING: The rear panel power cord connector is the mains power disconnect device. The device must be located in an open area that allows access to the cord connector.

The unit must be connected to a power supply only of the type and voltage specified on the rear panel. (USA: 120 V/60Hz, EC: 230V/50Hz)

Connect the component to the power outlet only with the supplied power supply cable or an exact equivalent. Do not modify the supplied cable. Do not use extension cords.

The mains plug is the disconnect of the unit. In order to completely disconnect the unit from the supply mains, remove the main plug from the unit and the AC power outlet. This is the only way to completely remove mains power from the unit.

The batteries in the remote control should not be exposed to excessive temperature such as sunshine, fire or other heat sources. Batteries should be recycled or disposed as per state and local guidelines.

Figure 1: Controls and Connections

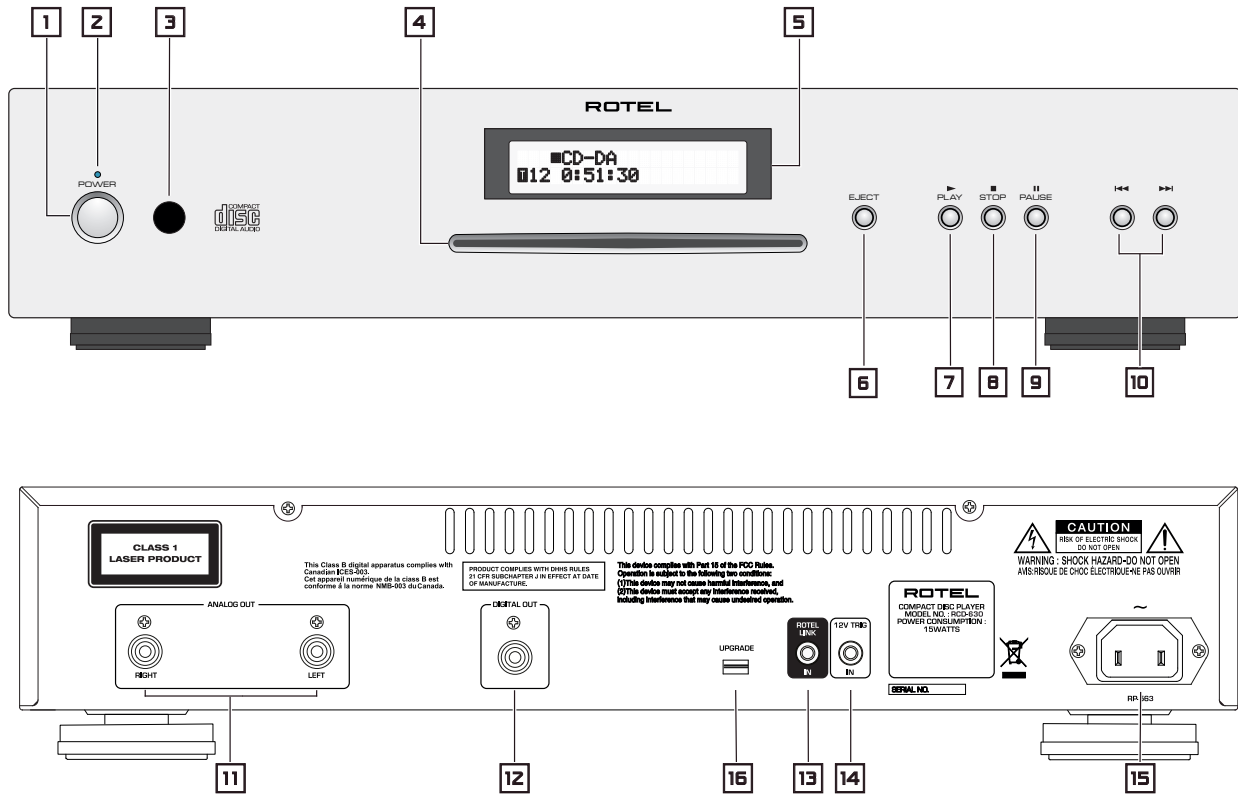

Figure 2: RR-D98 Remote Control

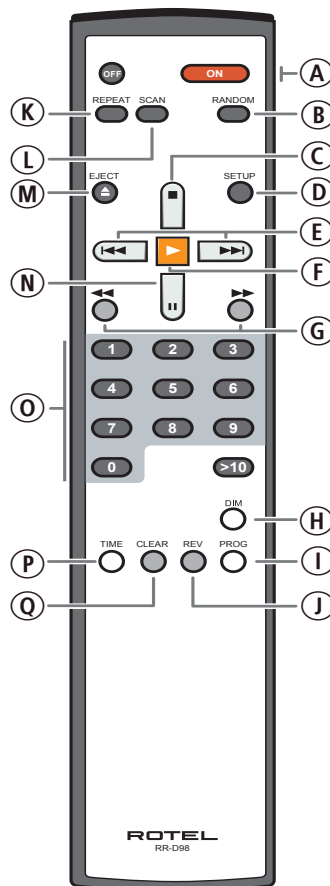
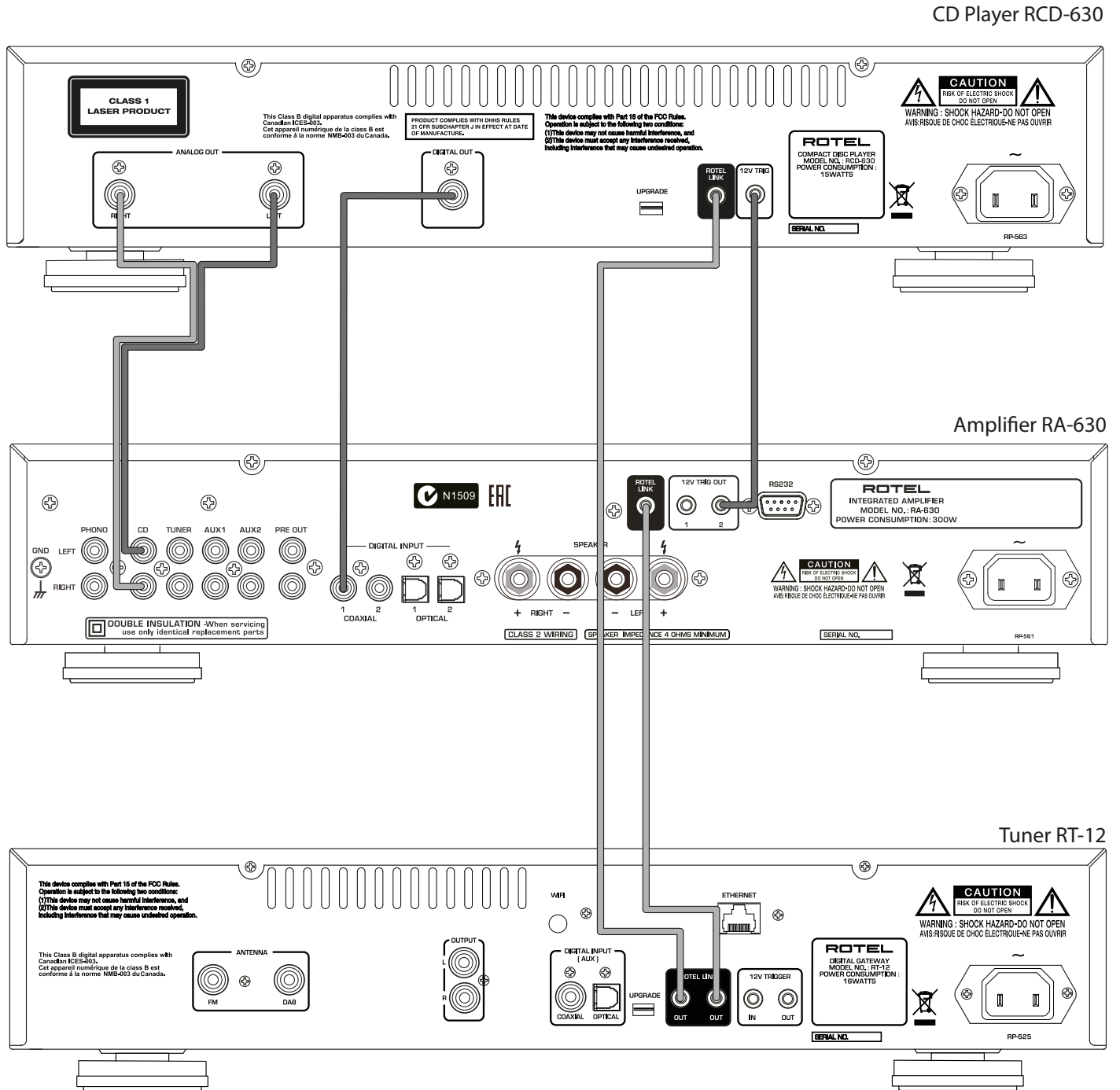





















Figure 3: Connections



Contents

Important Safety Instructions	3
Figure 1: Controls and Connections	4
Figure 2: Remote Control RR-D98	4
Figure 3: Connections	5
About Rotel	6
About the RCD-630	6
Getting Started	7
A Few Precautions	7
Placement	7
Control Identification	7
AC Power and Control	7
AC Power Input 	7
Power Switch  and POWER Indicator 	7
Output Connections	7
Analog Outputs 	7
Digital Output 	7
OPERATION	8
Infrared Remote Control 	8
Display 	8
Disc Loader Slot 	8
Transport Control Buttons	8
EJECT Button 	8
PLAY Button 	8
STOP Button 	8
PAUSE Button 	8
TRACK Buttons 	8
DIRECT ACCESS Buttons 	8
SEARCH Button 	9
Additional Features	9
Rotel Link 	10
12V Trigger Connection 	10
Remote Control Advanced Buttons	10
SETUP Button 	10
DIM Button 	10
UPGRADE USB mini socket 	10
Troubleshooting	11
Power Indicator Is Not Illuminated	11
Fuse Replacement	11
NO SOUND	11
Specifications	11

About Rotel

Our story began over 50 years ago. Over the decades, we have received hundreds of awards for our products and satisfied hundreds of thousands of people who take their entertainment seriously – like you!

Rotel was founded by a family whose passionate interest in music led them to manufacture high-fidelity components of uncompromising quality. Through the years, that passion has remained undiminished and the family goal of providing exceptional value for audiophiles and music lovers, regardless of their budget, is shared by all Rotel employees.

Rotel's engineers work as a close team, listening to, and fine tuning, each new product until it reaches their exacting musical standards. They are free to choose components from around the world in order to make that product the best they can. You are likely to find capacitors from the United Kingdom and Germany, semiconductors from Japan or the United States, while toroidal power transformers are manufactured in Rotel's own factory.

We all have concerns about our environment. And, as more and more electronics are produced it is especially important for a manufacturer to do all it can to engineer products that have a minimum impact on the environment.

At Rotel, we are proud to do our part. We have reduced the lead content in our products by using special lead-free ROHS solder and components. Our engineers continually strive to improve power supply efficiency without compromise to quality. When in standby mode Rotel products use minimal power to meet global Standby Power Consumption requirements.

The Rotel factory is also doing their part to help the environment through constant improvements to product assembly methods for a cleaner and greener manufacturing processes.

All of us at Rotel thank you for buying this product. We are sure it will bring you many years of enjoyment.

About the RCD-630

Simply stated, the RCD-630 is designed to do one thing—deliver the most detailed, nuanced sound from every disc. Whether it is a conventional CD, or an MP3 or WMA encoded disc, the RCD-630 will faithfully reproduce all that is recorded on the disc. While the RCD-630 was under development. The design team went far beyond the usual measurable technical performance characteristics. Listening panels spent hundreds of hours fine tuning the audio performance, choosing the components that produced the best sound, that would “release the emotion in the music”. Whatever the artist and recording engineers put on the disc, the RCD-630 will deliver.

That said, the RCD-630 does feature some impressive hardware. The digital-to-analogue converter is a state of the art DAC from the world renowned British manufacturer, Wolfson. This very high performance stereo DAC is specifically designed for audio applications such as CD, DVD, and home theatre systems. All this, combined with Rotel's Balanced Design, ensures the RCD-630 will deliver the highest level of audio performance. When used in a high-quality audio system, your Rotel CD player will provide years of enjoyment.

Getting Started

A Few Precautions

WARNING: To avoid potential damage to your system, turn off ALL the components in the system when connecting or disconnecting the loudspeakers or any associated components. Do not turn the system components back on until you are sure all the connections are correct and secure.

Please read this manual carefully. In addition to installation and operating instructions, it provides valuable information on various RCD-630 system configurations as well as general information that will help you get optimum performance from your system. Please contact your authorized Rotel dealer for answers to any questions you might have. In addition, all of us at Rotel welcome your questions and comments.

Save the RCD-630 shipping carton and all enclosed packing material for future use. Shipping or moving the RCD-630 in anything other than the original packing material may result in severe damage that is not covered by the warranty.

If included in the box please fill out and send in the owner's registration card. Also be sure to keep the original sales receipt. It is your best record of the date of purchase, which you will need in the event warranty service is required.

Placement

Use common sense when placing the RCD-630 in a cabinet or when stacking other equipment. Make sure that the shelf or cabinet can support its weight. Do not stack heavy components on top of the RCD-630. Avoid placing the unit where it may be subject to excessive heat such as on top of a large power amplifier or near a heat register. For best performance, avoid placing the unit where it may be subject to vibration, such as near a speaker.

Control Identification

This manual shows illustrations of the front and rear panels and the RR-D98 remote control. Each item in the illustrations is identified with a call out in a grey box. Through out this manual the items referred to in the text are identified by the corresponding call out. The items on the front and rear panels are identified with a number call out, such as **1**. The items on the remote control are labeled with a letter call out, such as **A**.

AC Power and Control

AC Power Input **15**

Your RCD-630 is configured at the factory for the proper AC voltage in the country where you purchased it (either 120 volts or 230 volts). The AC line configuration is noted on a decal on the back panel.

NOTE: Should you move your CD player to another country, it may be possible to reconfigure it for use on a different line voltage. Do not attempt to perform this conversion yourself. Opening the enclosure of the RCD-630 exposes you to dangerous voltages. Consult a qualified service person or the Rotel factory service department for information.

NOTE: Some products are intended for sale in more than one country and as such are supplied with more than one AC cord. Please use only the cord appropriate for your country/region.

The RCD-630 should be plugged directly into a 2-pin polarized wall outlet or into the switched outlet on another component in your audio system. Do not use an extension cord.

Be sure the power switch on the front panel of the RCD-630 is turned off (in the "out" position). Then, connect the supplied power cord to the AC power receptacle on the rear of the unit and the AC power outlet.

If you are going to be away from home for an extended period of time such as a month-long vacation, it is a sensible precaution to unplug your CD player (as well as other audio and video components) while you are away.

Power Switch **1** **A** and POWER Indicator **2**

Press the front panel Power Switch button **1** to turn the unit on. The Power Indicator light **2** is illuminated when the unit is on. Press Power Switch button again to turn the unit off.

When the power switch is in the ON position, the remote control ON and OFF buttons may be used to activate the RCD-630. In Standby mode the power LED remains illuminated, but the display is turned off.

Output Connections

The RCD-630 gives you a choice of two different kinds of output connections — an analog output signal from the built-in D/A converter for use with conventional analog audio components and a coax digital output which provides an unprocessed digital data signal for use with outboard D/A converters or digital processors.

NOTE: To prevent loud noises that neither you nor your speakers will appreciate, make sure the CD player is turned off when you make any signal connections.

Analog Outputs **11**

See Figure 3

A pair of standard RCA jacks supplies an analog output signal from the RCD-630 to the source inputs of an audio preamplifier, integrated amplifier, or receiver.

Select high quality audio interconnect cables. Connect the left channel output of the RCD-630 to the left channel source input on the preamplifier or other component. Connect the right output of the RCD-630 to the right channel source input on the preamplifier or other component.

Digital Output **12**

See Figure 3

If you are using an outboard D/A converter or other digital processor, you will need an unprocessed digital data stream from the RCD-630, taken before the built-in D/A converter. This signal is supplied by The RCD-630's back panel digital output jack. Using a standard 75 ohm coax digital cable, connect the RCD-630's coax digital output to the coax digital input connector on the outboard D/A converter.

NOTE: When playing CD-DA, MP3 and WMA discs, the Digital Output provides a PCM data stream.

OPERATION

The RCD-630 can be operated using its front panel buttons or from corresponding buttons on the supplied infrared remote control. Specific instructions for each of these controls are detailed below. Most of the buttons are duplicated on the front panel and on the IR remote control. However, there are a few exceptions where the buttons are only available on one or the other. These exceptions are noted in the instructions.

Infrared Remote Control

Before using the IR remote control, it is necessary to install two "UM-4/AAA" batteries (supplied). Remove the plastic cover on the back of the IR remote, install the batteries (observing the + and - polarity indications), and reinstall the cover.

To use the IR remote control, aim it at the IR sensor  located on the front panel of the RCD-630.

Display

A lighted Display on the front panel of the RCD-630 provides useful information about the status of the unit, activation of special features, and track/time information for the disc being played. Each of these indicators is described in the detailed operating instructions that follow.



Disc Loader Slot

A motor-driven slot loader, located in the center of the RCD-630, accept a compact disc. Place the compact disc into the slot, label-side up. Make sure the disc is properly centered before loading. The disc can be ejected by pressing the eject button as explained below.

Transport Control Buttons



These buttons provide basic control functions for the disc transport mechanism. Except where noted, all functions are available on the RCD-630 front panel and the IR remote control.

EJECT Button





When a disc is inserted into the front panel Disc Slot it is pulled into the disc transport. To eject the disc press the EJECT button  on the front panel or the remote control. If you accidentally press either of these buttons, press the button again to re-load the disc.

When the EJECT button  is pressed, the Display will read "EJECT". Once the disc is completely ejected, the display will read "NO DISC". When a disc is loaded, the Display will indicate the number of tracks on the disc and the total time of the disc in minutes and seconds.



PLAY Button

After the disc is loaded, press the PLAY button  to start playing the disc. The number of the track being played and the elapsed time will be shown in the display, along with the PLAY indicator. Normally, the disc will start playing with the first track. However, you can select a different track using the TRACK buttons or the DIRECT ACCESS buttons (see below) before pressing the PLAY button  to start playing a different selection.



STOP Button

Press the STOP button  once to stop disc play. Press the PLAY button  to resume disc play where it was stopped. If the STOP button  is pressed twice, disc play stops, the display shows STOP and programmed selections are deleted (see below). When the PLAY button  is pressed after pressing the STOP button  twice, the disc begins playing from the first track.

PAUSE Button

This button is used to temporarily suspend play. The disc continues to spin and play will be resumed from the current position. The PAUSE indicator will light in the Display. To resume playing the disc, press the PAUSE button  again or press the PLAY button .

TRACK Buttons

These buttons are used to select tracks on the disc. When a disc is playing, pressing the right TRACK button  advances to the beginning of the next track. Pressing the left TRACK button  returns to the beginning of the previous track. The new track number appears in the Display.

These buttons are also used to select a track before pressing the PLAY button  or when memorizing tracks for the PROGRAM play mode (see below). These selections are made by continuously pressing the TRACK buttons until the desired track is reached.

In PROGRAM mode, the TRACK buttons advance or reverse to the next track in the memorized selection list.

DIRECT ACCESS Buttons

Remote Only

These eleven numeric buttons (labelled 1 through 0 and >10) are used to directly access a track from the IR remote control instead of stepping through the tracks using the TRACK buttons.

The first ten tracks on a disc can be selected by pressing the corresponding button. For example, to play the third track, press the 3 button on the remote control.



When accessing track numbers greater than 10, press the >10 button followed by the track number. For example, to select track 12, press the >10 button followed by the 1 button and then the 2 button.

The number of the selected track will appear in the main numeric area at the center of the Display.

The DIRECT ACCESS buttons may also be used to memorize tracks in PROGRAM mode (see below).

SEARCH Button

Remote Only

These buttons  /  fast forward or fast reverse through the currently playing disc. One press of these buttons will fast forward or fast reverse at 2X normal speed. Press these buttons repeatedly will fast forward or fast reverse at 4X, then 8X, 16X, and 32X normal speed. One more press of these buttons, or by pressing PLAY button returns the player to normal speed. While the buttons are pressed, you will hear high-speed audio.

Additional Features

These convenience features add extra functionality to the RCD-630, including the ability to memorize a group of tracks to be played, to repeat a disc, program, or track over and over, to play the tracks on a disc in random order, to automatically play the first 10 seconds of each track, and to select from several available time displays.

PROGRAM Button

Remote Only

This button, labeled PROG, allows you to memorize as many as 20 tracks on the current disc for playback in a specific order. For example, you could instruct the RCD-630 to play track 5, followed by track 3, followed by track 8.

NOTE: Programmed play lists cannot be set up with MP3 and WMA discs.

To begin a program:

1. Insert a disc into the slot loader. The RCD-630 will read the contents of the disc.
2. Press the PROG button on the remote control. The PROGRAM indicator will light up in the Display, along with "P-00" indicating that the unit is waiting for the first track to be memorized.
3. Enter the first track number using the DIRECT ACCESS buttons. Your selection will be memorized automatically and the Display indicator will change to "P-01", indicating that one track has been memorized. Continue entering the rest of your selections using the DIRECT ACCESS buttons. Note that there is no need to press the PROG button as each selection is memorized as it is entered.

Once you have memorized a play list, the RCD-630 remains in PROGRAM mode until you eject the disc or press the STOP button twice in succession. If you press the PLAY button , the memorized program will play instead of the entire disc, starting with the first selection in the memorized list.

When a PROGRAM has been memorized, most functions that would normally affect the entire disc operate on just the memorized program. For example, the TRACK buttons advance to the next track in the memorized program, not the next track on the disc. Likewise, the REPEAT button (see below) continuously plays the memorized program, not the entire disc.

NOTE: The Random Play feature can not be used when using the Programmed Play feature.

REVIEW Button

Remote Only

This button is used to review the memorized tracks in PROGRAM mode. Press the button and the first memorized track number will appear in order in the Display, for approximately five seconds. Pressing the REV button again while the track number is displayed will continue the review sequence, showing the next memorized track. Continue pressing the REV button to see the complete memorized track list.

If you do not press the REV button while the track number is displayed, the review process is terminated and the unit resumes whatever mode it was in before you started to review.

Note that you may remove a selection from the play list during the review procedure using the CLEAR button, as described below.



CLEAR Button

Remote Only

This button allows you to remove a track selection from the memorized program play list during the review procedure described above. Follow the review procedure until the desired track number is displayed. Then, instead of pressing the REVIEW button to continue, remove the displayed track by pressing the CLEAR button while the number is still showing. You may then continue the review procedure.



RANDOM Button

Remote Only

This instructs the CD player to play tracks from the entire disc in random order. Once all of the selections have been played once, the disc will stop playing, unless the REPEAT Button (see below) has been engaged, in which case the random play will continue until the STOP button  is pressed. When the RANDOM button is engaged, an  icon will be displayed.

REPEAT Button

Remote Only

This button allows you to repeat the current track or the entire disc continuously until the feature is cancelled by disengaging the REPEAT button or pressing STOP . The REPEAT button steps sequentially through the available options. Press the button once and the RCD-630 will repeat just the current track, displaying the icon  in the Display. Press the button a second time and the RCD-630 will repeat the entire disc, displaying  in the Display. Press the button a third time to cancel the REPEAT function.

As noted above, REPEAT can be used in conjunction with the RANDOM play feature.

NOTE: The REPEAT function is automatically cancelled when the disc is ejected.

SCAN Button

Remote Only

This feature automatically plays the first ten seconds of each track on the disc (or the memorized program). To activate the feature, press the SCAN button. The  icon appears in the Display. To stop scanning and resume normal operation at the current track, press the SCAN button again or press the PLAY button.

TIME Button

Remote Only

Normally, the RCD-630 displays the elapsed time of the currently playing track. The TIME button allows you to step through two alternative time displays. Pressing the button once displays the time remaining in the current track, which counts down as the track continues playing. Pressing the button a second time displays the time remaining on the entire disc (or memorized program). Pressing the button a third time reverts to the standard elapsed time display. When the TIME feature is activated, the icon  appears in the Display in front of the time.

NOTE: When playing MP3 and WMA discs, only the regular elapsed time and the time remaining in the current track can be displayed.

Rotel Link

This 3.5 mm stereo mini-jack (labeled ROTEL LINK IN) can optionally attach to Rotel network enabled products with ROTEL LINK OUT connections. This allows the attached Rotel products to communicate with each other and be controlled via the Rotel Remote App (available for download on the iTunes® store).

12V Trigger Connection

The RCD-630 can be activated by a 12 volt trigger signal from a Rotel preamplifier. The trigger input accepts any control signal (AC or DC) ranging from 3 volts to 30 volts. When a cable is connected to the input and a trigger signal is present, the CD Player is activated. When the trigger signal is interrupted, the unit goes into standby mode. The front panel indicator light remains lit, but the display goes dark and the unit will not operate.

NOTE: When using the 12V Trigger feature, leave the POWER button in the ON position.

NOTE: If you are using other units in the series with Rotel link, please use the Rotel Link connection to turn the units on or off. Do not connect both the Rotel Link and 12V trigger cables. The 12V trigger's power on or off features will override the Rotel Link features.

Remote Control Advanced Buttons

SETUP Button

Remote Only

By pressing the SETUP button, you can enter the following setup menu:

- DIMMER: Changes the display brightness.
-

NOTE: This setting is stored permanently even after the RCD-630 is powered off.

- FACTORY DEFAULT: Resets to factory default. Select <YES> and press PLAY to confirm.

- VERSION: Shows the current software version.

- DISPLAY CONTRAST: Changes the front panel display contrast between the back light and the actual characters.
-

NOTE: This setting is stored permanently even after the RCD-630 is powered off.

- AUTO POWER OFF: The RCD-630 can be configured to automatically power off if unused for a specified period. If the CD is paused or stopped for the specified "Auto Power Off" timer the unit will automatically go to STANDBY mode. The Auto Power Off timer will be restarted if the CD starts to play. The default for Auto Power Off is set to DISABLE.

Valid settings include: DISABLE, 30 mins, 60 mins, 90 mins.

- EXIT: Exits this SETUP menu.

From the remote control, press the STOP/PAUSE/TRACK keys to change the contents of the menu, press PLAY to enter the setting or confirm.

NOTE: You can also access the SETUP menu without the remote control. Press the STOP key on the front panel for 5 seconds. Press the TRACK buttons to change the contents of the menu and press STOP to enter the settings or confirm.

DIM Button

Remote Only

Press the DIM key sequentially to change the DISPLAY brightness.

NOTE: Adjustments made using the  button are temporary only and not saved after powering off the RCD-630.

UPGRADE USB mini socket

This socket is reserved for future software upgrades when necessary.

Troubleshooting

Most difficulties in audio systems are the result of incorrect connections, or improper control settings. If you encounter problems, isolate the area of the difficulty, check the control settings, determine the cause of the fault and make the necessary changes. If you are unable to get sound from the RCD-630, refer to the suggestions for the following conditions:

Power Indicator Is Not Illuminated

The Power Indicator and the basic items in the Display window should be illuminated whenever the RCD-630 is plugged into the wall power outlet and the Power button is pushed in. If it does not light, test the power outlet with another electrical device, such as a lamp. Be sure the power outlet being used is not controlled by a switch that has been turned off.

Fuse Replacement

If another electrical device works when plugged into the power outlet, but the Power Indicator and the Display still will not light when the RCD-630 is plugged into the wall outlet, it indicates that the internal power fuse may have blown. If you believe this has happened, contact your authorized Rotel dealer to get the fuse replaced.

NO SOUND

Check the cables between the RCD-630 and the amplifier inputs to be sure they are connected properly. Be sure the correct amplifier input is selected. Be sure the tape monitor system of the amplifier has not been activated. Check the wiring between the amplifier and the speakers.

Specifications

Total Harmonic Distortion + Noise	0.0045% @ 1 kHz
Intermodulation Distortion	0.0045% @ 1 kHz
Frequency Response (± 0.5 db)	20-20,000 Hz
Channel Balance	± 0.5 db
Phase Linearity	± 0.5 degree
Channel Separation	> 98 dB @ 1 kHz
Signal to Noise Ratio	> 100 dB
Dynamic Range	> 96 dB
Digital to Analog Converters	Wolfson
Analog Output impedance	100 Ohms
Speed Accuracy, WOW & Flutter	Quartz Crystal Precision
Digital Output	0.5 Volt, Peak to Peak
Load Impedance	75 Ohms
Power Requirements (AC)	120V, 60 Hz (USA) 230V, 50 Hz (Europe)
Power Consumption	15 Watts
Standby Power Consumption	<0.5 Watts
BTU	51 BTU/h
Dimensions (W, H, D)	430 x 93 x 312 mm 17" x 3 ⁵ / ₈ " x 12 ² / ₈ "
Panel Height	80 mm / 3 ¹ / ₈ "
Weight (net)	5.5 kgs, 12.1 lbs.

All specifications are accurate at the time of printing. Rotel reserves the right to make improvements without notice.

Rotel and the Rotel HiFi logo are registered trademarks of The Rotel Co., Ltd. Tokyo, Japan.

警告

电击危险，请勿打开！

警告：为避免触电危险，非专业人员请勿打开机壳！

 本标记用于提醒用户，本产品内有未绝缘的危险电压，可能引致触电风险。

 标记提醒用户遵从本手册及随附文件中的操作和维护（维修）指引。

适用于美国、加拿大、或其它核准使用的地方。

小心：避免触电，请将宽片插头对准宽口插座。完全插入。

注意：为避免触电，请将插头最大（长）的那片（头）插入插座相应端口并插到底。

This Class B digital apparatus complies with Canadian ICES-003.

Cet appareil numérique de la classe B est conforme à la norme NMB-003 du Canada.

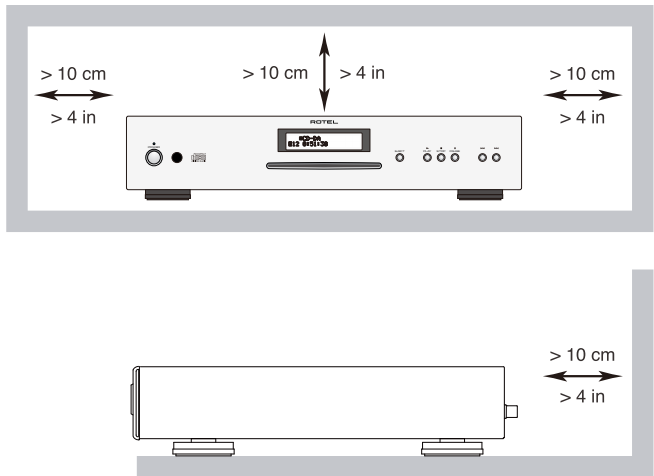

**CLASS 1
LASER PRODUCT**

激光产品重要安全说明

1. 1类激光产品
2. 危险：打开机壳且联锁机构故障或旁通时，会有可见激光辐射。避免直接接触激光光束。
3. 小心：不要打开上盖。本播放机内没有用户可以维修的部件；请合格维修人员进行维修工作。

警告：

- 要减少触电、火灾等：**
1. 不要拆卸螺钉、盖板或机壳。
 2. 不要将本产品置于雨水或潮湿环境中。
 3. 不要用湿手触摸电源线或插头。



洛得产品符合电气和电子设备限制有害物质（RoHS）以及处理废旧电气和电子设备（WEEE）的国际指令。带叉形符号的轮式垃圾箱标志指合乎规定，且该产品应根据这些指令以适当的方法进行回收或处理。



本符号表示本装置有双重保护。无需接地。

注意

后板上的迷你USB接口仅由授权人士操作。

FCC信息

本设备已经过测试，根据FCC规则第15部分的规定，符合B类数字设备的限制。这些限制旨在为居家安装环境中针对有害的干扰提供合理的保护。本设备会产生、使用及发射无线电频率能源，如果未依照指示安装及使用，将会导致对无线电通讯产生有害干扰。

但是，我们不保证在特定的安装方法之下不会产生干扰。如果本设备的确对广播或电视接收造成干扰（这些干扰可通过开启和关闭设备确定），我们鼓励用户尝试通过以下一种或多种方法更正干扰情形：

- 调整接收天线的方向或位置（电视机、收音机等）；
- 增加设备和接收天线之间的距离；
- 将设备连接到与接收器的插头所连接的不同电路插座上；
- 向经销商或有经验的广播/电视技术人员寻求帮助。

小心

本装置符合FCC规则第15部分的要求。操作本装置受限于以下条件：(1) 本装置不得导致有害的干扰；(2) 本装置一定会接受任何受到的干扰，包括可能导致意外操作的干扰。

CATV系统安装人员注意事项：提醒CATV系统或天线安装人员注意国家电气规范第820-40节的内容。它提供了进行正确接地的指引，尤其是规定了接地电缆必须连接到建筑的接地系统上，尽量靠近电缆接入点。请参阅安装图。

重要安全说明

警告：机内无客户可以维修的部件。请合格维修人员维修。

警告：为减少火灾或触电的危险，不要将本产品置于潮湿环境中或水中，不要将本产品置于滴水或溅水环境中，不要将含有液体的物件（例如花瓶）放在本产品上，不要让异物进入本产品外壳内。如果本产品进入潮湿环境中，或异物进入本产品内，立即从墙上拔掉电源线，将本产品送交合格维修人员检查或进行必要的维修。

请仔细阅读所有说明。

请保留所有说明手册。

请留意这些说明和装置上的所有警告。

请遵从操作说明。

不要在接近水的地方使用本产品。

只能用于布清洁。

不要堵塞本装置任何通风口。请依照制造商的指导进行安装。

请勿将本装置安置于靠近辐射、热源、火炉或其它发热器具（包括放大器）的地方。

请注意两极插头或接地插头的安全作用。两极插头有两个插刀，其中一个插刀比另一个宽。接地插头有两个插刀和第三个接地插刀。这些都是为了您的安全。如果随本产品提供的插头与您的插座不匹配，请咨询电工更换陈旧的插座。

请合理放置电源线，避免踩踏或挤压插头、简易插座以及从本装置拔插的部分。

只能使用制造商指定的附件或配件。

只能使用制造商指定或随本装置一同出售的机架、立架、支架或桌子。在支架或机架上移动本装置时，请小心避免因机器或机架翻倒导致受伤。



雷暴天气中或本装置长时间不使用时，应将电源插头从插座中拔出。

若本装置有任何损坏，如电源线或插头损坏，异物或液体进入装置中，本装置遭受雨淋或受潮，本装置显示不正确操作的迹象或本装置跌落时，立即停止使用，并请合格维修机构检测和维修。

本产品应在非热带气候条件下安全使用。

本产品周围最少应有10cm或4in.的间隙。

警告：后面板上的电源线接头是主电源断开装置。应该将本机放在可拔插电源线接头的开放的地方。

只能将本产品连接到后面板指定的型号和电压的电源上。

（美国：120V/60Hz，欧洲：230V/50Hz，中国：220V/50Hz）

只能用本产品提供的电源线或严格等同的电源线将本产品连接到电源插座上。不得更改随本产品提供的电源线。不要使用延长线。

电源电缆的主插头是本产品的断电装置。要将本产品从电源完全断开，应从主（交流）插座上拔下电源电缆的主插头。这是机器唯一的彻底断电方式。

请勿将遥控器内的电池暴露于如阳光、火源等类似的高温条件下。电池的循环再用与废弃应遵循当地法律法规。

图 1: 控制和连接



图 2: RR-D98遥控器



图 3: 连接

CD 播放机 RCD-630

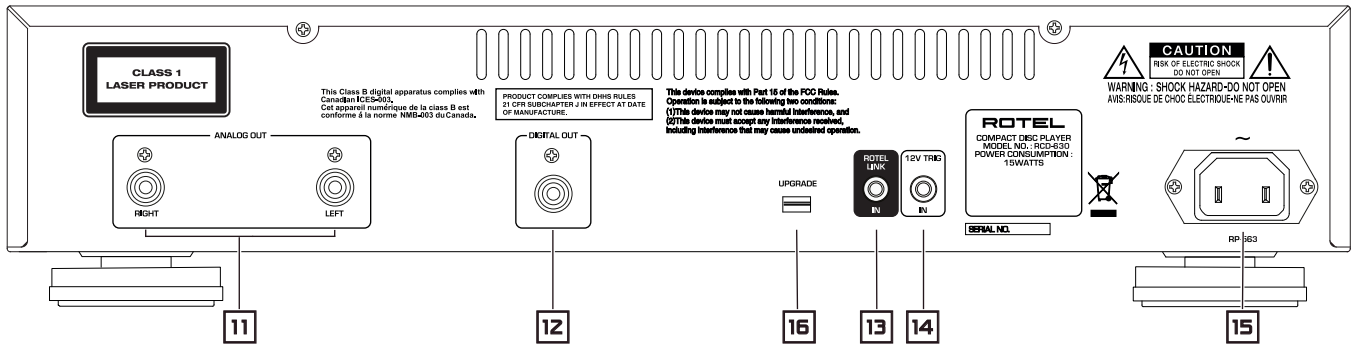
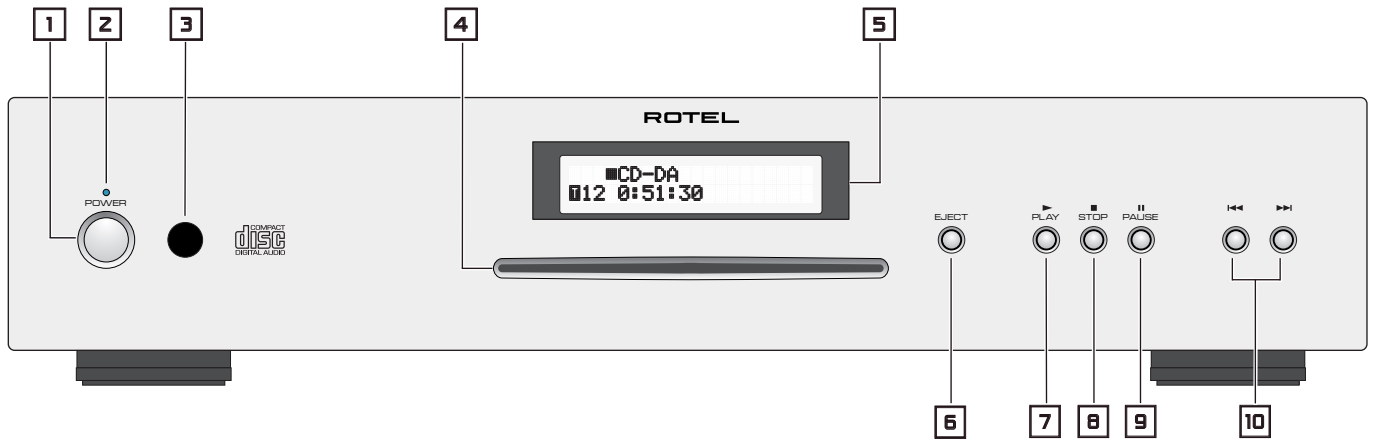

放大器 RA-630

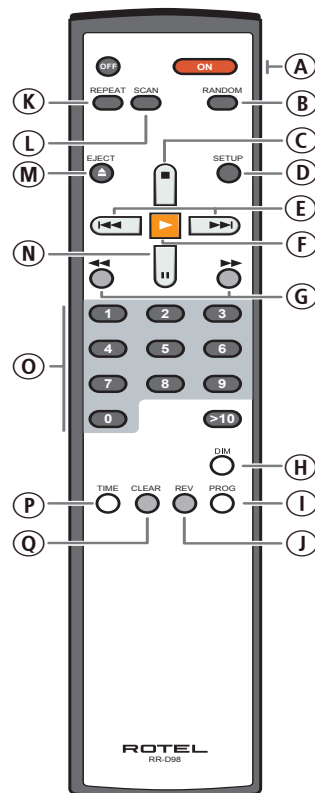
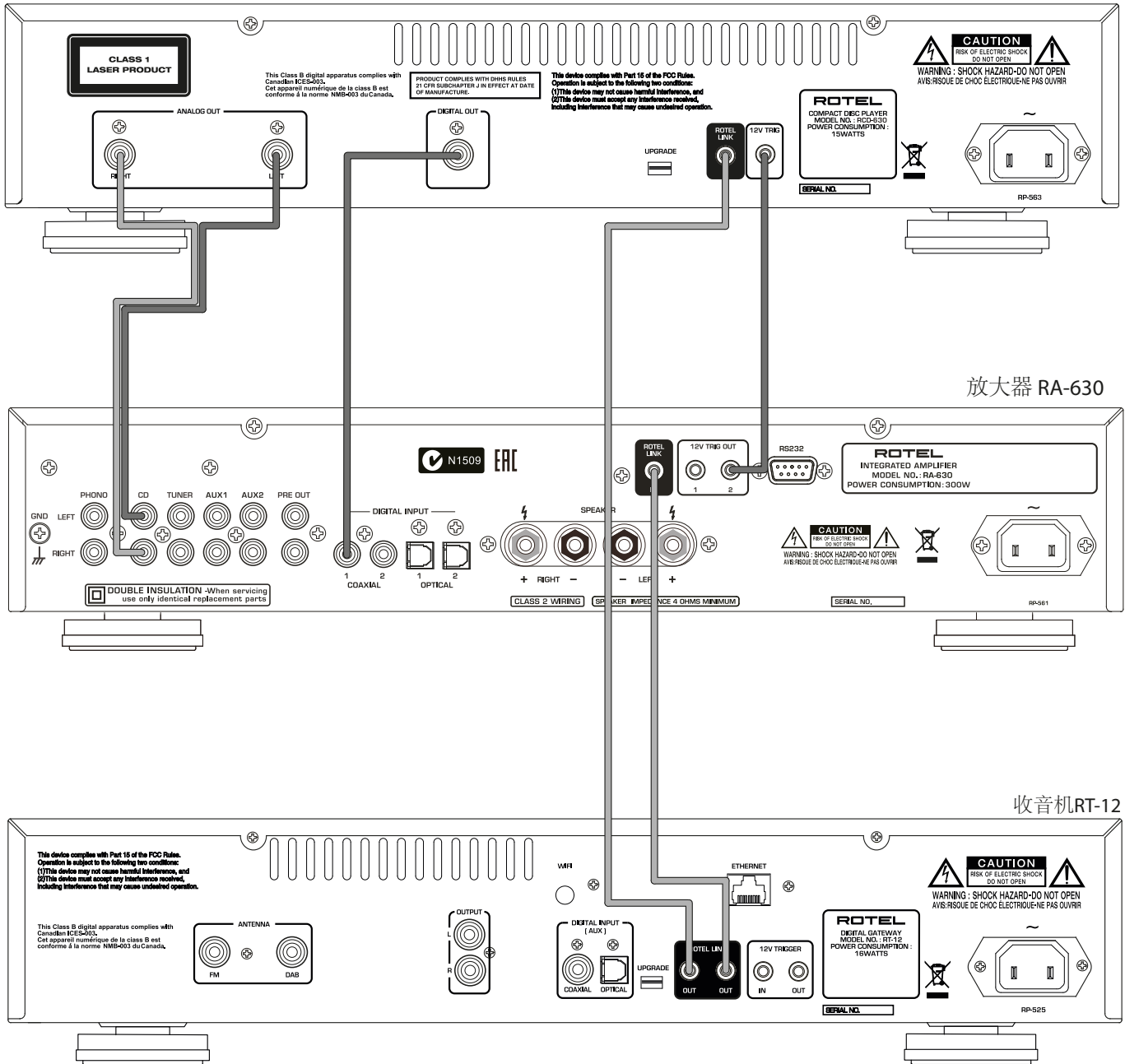
收音机 RT-12

目录

重要安全说明	13
图1: 控制和连接	14
图2: RR-D98遥控器	14
图3: 连接	15
关于洛得	16
关于RCD-630	16
开始使用	16
几点注意事项	16
放置	17
控制标识	17
交流电源和控制	17
交流电源输入 	17
电源开关  和电源指示灯 	17
输出连接	17
模拟输出 	17
数字输出 	17
操作	17
红外线遥控器 	17
显示屏 	17
光碟吸入口 	17
传送控制键	18
EJECT (出仓) 键 	18
PLAY (播放) 键 	18
STOP (停止) 键 	18
PAUSE (暂停) 键 	18
TRACK (音轨) 键 	18
DIRECT ACCESS (直接访问) 键 	18
SEARCH (搜索) 键 	18
附加功能	18
Rotel Link 	19
12V触发连接 	19
遥控器高级按键	19
SETUP (设置) 键 	19
DIM (调光) 键 	19
UPGRADE USB 迷你接口 	19
故障排除	20
电源指示灯不亮	20
更换保险丝	20
没有声音	20
技术参数	20

关于洛得

洛得已有超过50年的历史。几十年来，我们的产品已赢得数百次奖项，满足了无数对娱乐有着严肃态度的人士——比如您。

洛得是一个家族公司，他们对音乐的激情让他们致力于制造高品质的高保真音响设备。多年以来，这种激情丝毫未减，而为不同预算的高保真音响发烧友和音乐爱好者提供超值产品的目标，是洛得所有员工的共同追求。

洛得的工程师紧密协作，认真倾听并精确调谐每个新产品，直到其符合苛刻的音乐标准。他们从世界各地选择部件，以令其产品尽善尽美。您可能会发现英国和德国生产的电容器、日本和美国产的半导体，以及洛得自己的工厂制造的环形功率变压器。

我们十分关注环境。随着越来越多的电子产品出现，随后被废弃，制造商竭尽所能设计对垃圾填埋场和地下水位带来最低负面影响的产品就显得尤为重要。

在洛得，我们做到了这一点，我们对此深感自豪。通过使用特殊的ROHS焊料，我们大大地降低了电子产品中的铅含量，同时，洛得工程师一直在保证质量的前提下不断提高功率输出的效能。洛得产品在待机模式下仅需运行最低功率，符合国际待机功耗标准。

洛得还不断地研发更加清洁、更加环保的制造工艺，为环保事业贡献自己的力量。

洛得的全体同仁感谢您购买本产品。我们深信，本产品将为您带来数年的美妙享受。

关于RCD-630

简单而言，RCD-630的设计只为一个目标——演绎每张声碟最具细节、最细腻的天籁之音。无论是传统的CD、MP3或WMA解码的光碟，RCD-630都会忠实再现光碟上记录的所有细节。RCD-630尚在开发时，设计小组就已超越正常的可衡量的技术表现特性。听音小组耗费数百小时对音质表现进行精细的调节，选择可以再现最佳音质、可以“释放音乐情感”的元件。艺术家和录音师录制在音碟上的一切，RCD-630均能纤毫毕现地进行演绎。

这表明，RCD-630的确具备令人印象深刻的硬件。数字-模拟转换装置采用来自世界著名英国制造商Wolfson制造的顶尖数字-模拟转换装置（DAC）。这种极高性能的立体声DAC专为音频应用设计，例如CD、DVD及家庭影院系统。所有这些都与洛得的平衡设计相结合，确保RCD-630提供最高水准的音质表现。在高质量的音频系统中使用时，洛得CD播放机可向您提供数年的音乐享受。

开始使用

几点注意事项

警告： 要避免可能造成系统的损坏，进行连接或断开音箱或相关组件之前应关闭所有系统组件。确保所有连接均正确和安全后再开启系统组件。

请仔细阅读本手册。除了安装和操作说明外，本手册还提供了关于RCD-630系统设置的资料以及一般信息，帮助您优化系统的性能。如果您遇到任何问题，请联络洛得授权经销商。另外，洛得全体同仁欢迎您提出问题或建议。

请保存好RCD-630的包装箱和包装材料，以备日后使用。使用非原始包装材料运输或移动RCD-630可能导致严重损坏，而这些损坏不在保修范围内。

包装中若有用户注册卡，请填写并寄回给我们。另请保留原始销售收据。它是购买日期的最佳记录，您日后需要保修时会用到它。

放置

将RCD-630放置在机柜中或堆叠其它设备时应使用一般常识。请确保机架或机柜能够承载其重量。不要在RCD-630上放置设备。避免将本设备放在可能遭受过多热量的地方，例如大功率放大器上面或电热炉附近。为获得最佳性能，避免将本设备放在可能受到振动的地方，例如音箱附近。

控制标识

本手册显示了前后面板和RR-D98遥控器的图解。图解中的每个项目均用引出号码标识。本手册中，文字中所指的项目均用相应的引出号码标识。前后面板中的项目用数字引出码标识，例如①。遥控器上的项目用字母引出码标识Ⓐ。

交流电源和控制

交流电源输入 ⑤

RCD-630出厂时已设置到您购买本产品所在国家的交流电压（120 V或230 V，中国：220 V/50 Hz）。交流电压配置标注在背面板的标签上。

注意：如果将CD播放机带到另一个国家，可能需要重新设置以使用不同的电压。不要试图自行进行转换。打开RCD-630的外壳会有触电危险。请咨询合格的维修人员或洛得工厂服务部门寻求帮助。

注意：有些产品将出售于多个国家，因此提供了多条AC电源线，请选择一条适用于您的国家/地区使用的电源线。

RCD-630应直接插到两脚墙壁插座或音频系统中其它设备上的转换插座。不要使用延长线。

请确保RCD-630前面板上的电源开关已关闭（位于“弹出”的位置）。然后，将电源线插到本设备后面的交流电源插孔和交流电源插座上。

如果您将要离家较长时间，例如一个月，离开前请务必拔下CD播放机（和其它音频视频设备）的电源插头。

电源开关 ①Ⓐ 和电源指示灯 ②

要启动CD播放机，将前面板的电源开关键①按入。CD播放机启动时，电源指示灯②会变亮。要关闭CD播放机，再次按下电源开关键将其复位。

电源开关位于开的位置时，可以使用遥控器上的开（ON）和关（OFF）键激活CD播放机。在待机模式中，电源键周围的指示灯亮，但显示屏关闭。

输出连接

RCD-630为您提供两种输出连接选择 — 一种从内置D/A转换器输出的模拟输出信号，用于传统的模拟音频设备，一种同轴数字输出，提供未经处理的数字信号，用于外置的D/A转换器或数字处理器。

注意：要避免高噪声对您和音箱的影响，进行任何信号连接之前应关闭所有系统组件。

模拟输出 ⑩

见图3

一对标准RCA插孔从RCD-630向音频前置放大器、合并式放大器或接收器的音源输入发送模拟输出信号。

请选用高质量的音频互连电缆，将RCD-630的左右声道输出连接到前置放大器或其它设备的相应输入接口。

数字输出 ⑫

见图3

如果您使用外置D/A转换器或其它数字处理器，您需先从RCD-630内置的D/A转换器得到未经处理的数字数据流。该信号可通过RCD-630后面板的数字输出插孔进行传输。使用标准的75Ω同轴数字电缆，将RCD-630的同轴数字输出连接到外置D/A转换器的同轴数字输入接口。

注意：播放CD-DA、MP3及WMA光碟时，数字输出会提供PCM数据流。

操作

RCD-630可通过前面板的按键或随本机提供的遥控器上相应的按键进行操作。这些控制的具体说明在下面详述。在前面板和遥控器上的多数按键是一样的。但是，也有少数例外，有些按键只在前面板或遥控器上才有。这些例外情况在操作说明中均有提及。

红外线遥控器 ③

使用遥控器之前，应安装两只“UM-4/AAA”规格的电池（已提供）。将遥控器背面的仓盖打开，装入电池（注意正负极+/-指示），重新合上电池盖。

要使用红外线遥控器，将遥控器对准RCD-630前面板的红外线感应器③。

显示屏 ⑤

RCD-630前面板上的发光显示屏提供有关本装置状态、特别功能激活以及正在播放的碟片的音轨/时间等信息。各个指示灯在操作说明中均有详细描述。



光碟吸入口 ④

RCD-630中间的光碟吸入口，可接收插入的光碟。插入光碟，标签面向上。加载光碟前，确保光碟至于中间。按EJECT（出仓）键可弹出光碟，详见下面描述。

传送控制键



这些按键提供碟片传送机构的基本控制功能。除有特别说明之外，所有功能在RCD-630前面板和遥控器上均可用。

EJECT (出仓) 键





将光碟插入前面板光碟吸入口后，光碟被吸入光碟传送装置。要退出光碟，按前面板或遥控器上的EJECT (出仓)  键。如果不小心按下这两个按键，再按该键一次重新加载光碟。

当按下EJECT键  时，显示屏会显示“EJECT”。当光盘完全退出，显示屏会显示“NO DISC”。加载光盘时，显示屏会显示光盘的音轨数和光盘的分钟及秒总时间数。



PLAY (播放) 键

加载光碟后，按PLAY (播放)  键开始播放光碟。显示的音轨数和已播放时间会与播放指示灯一同显示在显示屏上。通常，碟片会从第一个音轨开始播放。但是，按播放键之前，您可以使用TRACK (音轨) 键或DIRECT ACCESS (直接访问) 键 (详见下文) 选择不同的音轨，开始播放不同的选择。



STOP (停止) 键

按STOP (停止) 键  一次停止播放光碟。按PLAY (播放) 键  从停止位置重新开始播放光碟。如果按STOP (停止) 键  两次，光碟播放停止，显示屏显示STOP (停止) 字样，所编程的选择被删除 (见下文)。如果按下STOP (停止) 键  两次后按 PLAY (播放) 键 ，会从第一个音轨开始播放光碟。

PAUSE (暂停) 键

按PAUSE (暂停) 键  暂时停止播放。碟片继续转动，并将会从当前位置开始重新播放。显示屏上的暂停指示灯点亮。要恢复播放光碟，再按一次PAUSE (暂停) 键  或按PLAY (播放) 键 。

TRACK (音轨) 键

这些按键用于选择光碟上的音轨。正在播放光碟时，按右TRACK (音轨) 键  可前往下一音轨的起始处。按左TRACK (音轨) 键  返回前一音轨的起始处。显示屏上会出现新的音轨编号。

在按PLAY (播放) 键  之前或在PROGRAM (编程) 播放模式下存储存储音轨 (详见下文) 时，这些按键还可以用于选择一个音轨。连续按TRACK (音轨) 键，直到找到您想要的音轨。

在PROGRAM (编程) 模式中，按TRACK (音轨) 键可向前或向后到达存储清单中的下一个音轨。

DIRECT ACCESS (直接访问) 键

(只能通过遥控器操作)

用遥控器上的这11个数字键 (标为1到0和>10) 可以直接访问任一音轨，代替TRACK (音轨) 键的逐步进入该音轨。

碟片中的前10个音轨可以通过相应的按键选择。例如，要播放第三个音轨，按遥控器上的数字键3。



要选择10以上的音轨，使用>10键。例如，要选择音轨12，先按>10键，然后按数字1键，再按数字2键。

所选音轨编号会出现在显示屏中间的主数字区域。

DIRECT ACCESS键还可以用来在编程模式下存储音轨。(见下文)

SEARCH (搜索) 键

(只能通过遥控器操作)

 /  键可用于快速向前或向后搜索当前播放的碟片。按这些键一次会以正常速度的两倍快速向前或向后搜索。重复按这些键会以正常速度的4倍、8倍、16倍及32倍快速向前或向后搜索。再多按一次，或按PLAY (播放) 键，返回正常播放速度。按下这些按键时，您会听到高速的音频。

附加功能

这些便利特性为RCD-630带来更多功能，包括存储一组要播放的音轨，重复播放碟片、节目或音轨，随机播放碟片上的音轨、自动播放各音轨的最初10秒，以及选择多种可用的时间显示。

PROGRAM (编程) 键

(只能通过遥控器操作)

本按键被标记为PROG (编程)，可让您存储当前碟片上多达20个音轨，用于以特定顺序进行播放。例如，您可以让RCD-630先播放音轨5，接着播放音轨3，然后播放音轨8。

注意：播放MP3和WMA光碟时不能使用编程播放清单。

要开始编程：

1. 将光碟插入前面板的插口。RCD-630将读取碟片的内容。
2. 按遥控器上的 PROG (编程) 键。显示屏中的PROGRAM指示灯点亮，并出现“P-00”，表明本设备正在等待存储第一个音轨。
3. 使用DIRECT ACCESS (直接访问) 键输入第一个音轨编号。您的选择被自动存储，显示屏指示将变为“P-01”，表明已经存储了一个音轨。继续用DIRECT ACCESS (直接访问) 键输入您的其它选择。请注意，由于每个选择在输入时已被存储，因而无需按 PROG (编程) 键。

存储了一个播放清单后，RCD-630会停留在编程模式，直至您退出光碟或连续按两次停止键。如果您按PLAY键 ，将会从存储清单中的第一个选择开始播放被存储的节目，而不是整个碟片。

编程被存储后，平常可影响整个碟片操作的多数功能只会对被存储的编程起作用。例如，按TRACK (音轨) 键会前往存储编程中的下一个音轨，而不是光碟上的下一个音轨。同样，按REPEAT (重复播放) 键 (见下文) 会连续播放被存储的编程，而不是整张光碟。

注意：使用编程播放功能时，无法使用随机播放功能。

REVIEW (浏览) 键

(只能通过遥控器操作)

本按键用于在编程模式下浏览被存储的音轨。按下本键，显示屏会出现第一个存储的音轨编号，显示大概5秒钟。音轨编号显示时再次按REV (浏览) 键，会继续进行浏览，显示下一个被存储的音轨编号。继续按浏览键查看完整的存储音轨清单。

如果未再次按下 REV (浏览) 键，则在5秒钟后终止浏览过程，播放机恢复到您开始浏览之前的模式。

在浏览过程中，您可以使用CLEAR (清除) 键从程序播放清单中清除音轨。

CLEAR (清除) 键

(只能通过遥控器操作)

本按键让您在上述浏览过程中从已经存储的编程播放清单中删除音轨。先进行浏览，直到看到您想清除的音轨编号。然后，在显示该音轨编号的同时按CLEAR (清除) 键删除该音轨。然后您可继续进行浏览。



RANDOM (随机播放) 键

(只能通过遥控器操作)

本按键让CD播放机以随机顺序播放整个碟片的音轨。所有选项被播放一遍后，将会停止播放，除非按下REPEAT重复键 (详见下文)，这种情况下，随机播放将会继续，直到您按下STOP (停止) 键 。按下RANDOM (随机播放) 键时，显示屏会出现  图标。

REPEAT (重复播放) 键

(只能通过遥控器操作)

本按键可让您重复播放当前音轨或整个碟片，直到再次按下REPEAT (重复播放) 键或按STOP (停止) 键取消本功能。REPEAT (重复播放) 键在可用的选择中连续步进。按本键一次，RCD-630只会重复播放当前音轨。显示屏上会出现  图标。第二次按本键，RCD-630会重复播放整张光碟。显示屏上会出现两个  图标。第三次按本键，取消重复播放功能。

如上文所述，重复播放可以与随机播放功能一同使用。

注意：退出光碟后，重复播放功能自动取消。

SCAN (扫描) 键

(只能通过遥控器操作)

本功能自动播放碟片中 (或存储编程中) 每个音轨的开始10秒。要激活本功能，按SCAN (扫描) 键。显示屏上会出现  图标。要停止扫描并重新开始对当前音轨进行一般操作，再次按SCAN (扫描) 键，或按PLAY (播放) 键。

TIME (时间) 键

(只能通过遥控器操作)

通常，RCD-630会显示当前音轨的已播放时间。TIME (时间) 键可让您切换到另一种时间显示模式。按本按键一次，显示当前音轨的剩余时间，剩余时间随着音轨继续播放进行倒计时。第二次按本按键，会显示整个碟片 (或存储的编程) 的剩余时间。第三次按本按键，将返回标准的已播放时间显示模式。当TIME (时间) 功能被激活，显示屏上会在时间前出现  图标。

注意：播放MP3和WMA光碟时，只能显示当前音轨的正常已播放时间和剩余时间。

Rotel Link

这个3.5毫米立体声迷你插孔 (标有ROTEL LINK IN) 与ROTEL LINK OUT连接，可让RCD-630与带网络功能的洛得产品相互连接。这样相连接的洛得产品可相互通讯并可通过Rotel App (洛得应用程序，可从iTunes®商店下载) 进行控制。

12V触发连接

RCD-630可用12V触发信号激活。TRIGGER INPUT接收任何3V至30V的控制信号 (交流或直流)。当有电缆连接到该12V输入接口且出现触发信号时，RCD-630播放机被激活。触发信号被中断时，本设备进入待机模式。前面板的电源指示灯继续点亮，但显示屏变黑，本设备停止工作。

注意：使用12V触发功能时，应将电源按键位于开 (ON) 的位置。

注意：在使用Rotel Link系列的其它设备时，请用Rotel Link 来开/关设备。不要同时连接Rotel Link和12V 触发电缆，否则12V 触发器的开/关电源功能将会覆盖Rotel Link连接功能。

遥控器高级按键

SETUP (设置) 键

(只能通过遥控器操作)

按下SETUP (设置) 键，将进入以下设置菜单：

- DIMMER (调光器) : 可改变显示屏的亮度。

注意：关闭RCD-630的电源后，该设置将被永久保存。

- FACTORY DEFAULT (出厂设置) : 可恢复到出厂设置。选择<YES> (是) 再按PLAY (播放) 键确认。

- VERSION (版本) : 显示当前软件版本。

- DISPLAY CONTRAST (显示对比度) : 设置显示屏对比度。

注意：关闭RCD-630的电源后，该设置将被永久保存。

- AUTO POWER OFF 自动关机：RCD-630设有自动关机功能。若在设定的“自动关机”时间内CD暂停或停止播放，机器则自动切换至待机 (STANDBY) 模式。若CD开始播放，自动关机计时器会重新计时。自动关机 (Auto Power Off) 出厂设置为禁止 (DISABLE) 。

可选计时设定包括：DISABLE (禁止)、30 mins (30分钟)、60 mins (60分钟) 和90 mins (90分钟) 。

- EXIT (退出) : 退出设置菜单。

通过遥控器，按STOP (停止) / PAUSE (暂停) / TRACK (音轨) 键改变菜单内容，按PLAY (播放) 键进入设置或确认。

注意：您还可以通过前面板进入设置菜单。按STOP (停止) 键5秒钟，然后按TRACK (音轨) 键改变菜单内容，再按STOP (停止) 键进入设置菜单或确认。

DIM (调光) 键

(只能通过遥控器操作)

按DIM键依次改变显示屏亮度。

注意：使用  键调节为临时性更改，关闭电源后则不被保存。

UPGRADE USB 迷你接口

该接口用于日后软件的更新。

故障排除

音响系统的多数故障是由于错误连接或控制设置不正确引致。如果您遇到问题，请屏蔽有问题的区域，检查控制器设置，确定故障原因并进行必要的修正。如果RCD-630仍然没有声音，请参考以下状况的建议：

电源指示灯不亮

RCD-630插到墙壁电源插座并且电源键被打开时，电源指示灯和显示屏的基本项目应该点亮。如果没有点亮，用其它电气设备例如台灯测试电源插座。确保电源插座没有被已断开的开关控制。

更换保险丝

如果其它电气设备插到该插座时可正常工作，但RCD-630插到同一插座且电源开关打开时电源指示灯和显示屏不亮，表明内置保险丝可能已烧断。如果您确信发生这种情况，请联络授权洛得经销商更换保险丝。

没有声音

检查RCD-630和放大器之间的电缆，确保已正确连接。确保放大器的磁带监听功能没有被激活。检查放大器和音箱之间的连线。

技术参数

总谐波失真+噪声	0.0045% @ 1kHz
互调失真	0.0045% @ 1kHz
频率响应 (± 0.5 dB)	20 - 20,000 Hz
声道均衡	± 0.5 dB
相位线性	± 0.5 度
声道隔离	> 98 dB @ 1kHz
信噪比	> 100 dB
动态范围	> 96 dB
数模转换器	Wolfson
模拟输出阻抗	100 Ω
速度精度，抖晃率	石英水晶精确等级
数字输出	0.5 V, 峰-峰值
负载阻抗	75 Ω
电源要求	
美国版本	AC 120 V, 60 Hz
欧洲版本	AC 230 V, 50 Hz
中国版本	AC 220 V, 50 Hz
功率消耗	15 W
待机功耗	<0.5 W
BTU	51BTU/h
尺寸 (宽×高×深)	430 x 93 x 312 mm 17 x 3 ⁵ / ₈ x 12 ² / ₈ in.
前面板高度	80 mm / 3 ¹ / ₈ in
重量 (净重)	5.5 kg, 12.1 lbs.

本手册印刷时所有参数均属精确。
洛得保留修改的权利，恕不另行通知。

Rotel和Rotel HiFi标记是日本东京洛得有限公司的注册商标。

中国洛得

珠海保税区洛得电子有限公司

地址：中国广东省珠海市珠海保税区第27号区域

电话：0756-8817222

传真：0756-8936222

The Rotel Co. Ltd.

日本洛得

Tachikawa Bldg. 1F.,

2-11-4, Nakane, Meguro-ku,

Tokyo, 152-0031

Japan

Rotel of America

美国洛得

54 Concord Street

North Reading, MA 01864-2699

USA

电话：+1 978-664-3820

传真：+1 978-664-4109

Rotel Europe

欧洲洛得

Dale Road

Worthing, West Sussex BN11 2BH

England

电话：+ 44 (0)1903 221 710

传真：+44 (0)1903 221 525

Rotel Deutschland

德国洛得

Vertrieb: B&W Group Germany GmbH

Kleine Heide 12

D-33790 Halle/Westf., Deutschland

电话：05201 / 87170

传真：05201 / 73370

电邮：info@bwgroup.de

www.rotel.com