

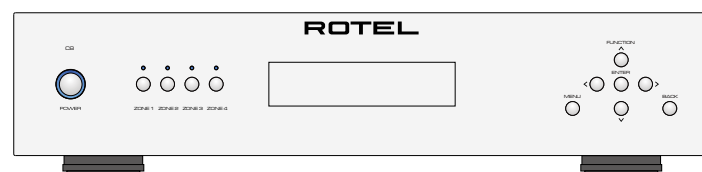

ROTEL®



C8

C8+

Eight Channel Power Amplifiers
Amplificateurs de Puissance Huit Canaux
Achtkanal-Endstufe
Etapas de Potencia de Ocho Canales
Achtkanaals vermogensversterkers
Amplificatori finali a otto canali
8-kanals slutsteg
8-канальный усилитель мощности

Owner's Manual
Manuel de l'utilisateur
Bedienungsanleitung
Manual de Instrucciones
Gebruikershandleiding
Manuale di istruzioni
Instruktionsbok
Инструкция пользователя

Important Safety Instructions

Notice

The RS232 connection should be handled by authorized persons only.

WARNING: There are no user serviceable parts inside. Refer all servicing to qualified service personnel.

WARNING: To reduce the risk of fire or electric shock, do not expose the unit to moisture or water. Do not expose the unit to dripping or splashing. Do not place objects filled with liquids, such as vases, on the unit. Do not allow foreign objects to get into the enclosure. If the unit is exposed to moisture, or a foreign object gets into the enclosure, immediately disconnect the power cord from the wall. Take the unit to a qualified service person for inspection and necessary repairs. Read these instructions.

Keep these instructions.

Heed all warnings.

Follow all instructions.

Do not use this apparatus near water.

Clean only with dry cloth.

Do not block any ventilation openings. Install in accordance with the manufacturer's instructions.

Do not install near any heat sources such as radiators, heat registers, stoves, or other apparatus (including amplifiers) that produce heat. Do not defeat the safety purpose of the polarized or grounding-type plug.

A polarized plug has two blades with one wider than the other.

A grounding type plug has two blades and a third grounding prong.

The wide blade or the third prong are provided for your safety. If the provided plug does not fit into your outlet, consult an electrician for replacement of the obsolete outlet.

Protect the power cord from being walked on or pinched particularly at plugs, convenience receptacles, and the point where they exit from the apparatus.

Only use attachments/accessories specified by the manufacturer.

Use only with the cart, stand, tripod, bracket, or table specified by the manufacturer, or sold with the apparatus.



When a cart is used, use caution when moving the cart/apparatus combination to avoid injury from tip-over.

Unplug this apparatus during lightning storms or when unused for long periods of time.

Refer all servicing to qualified service personnel. Servicing is required when the apparatus has been damaged in any way, such as power supply cord or plug is damaged, liquid has been spilled or objects have fallen into the apparatus, the apparatus has been exposed to rain or moisture, does not operate normally, or has been dropped.

The apparatus should be used in non tropical climate.

You must allow a minimum 50 cm or 20 inches of unobstructed clearance around the back of the unit.

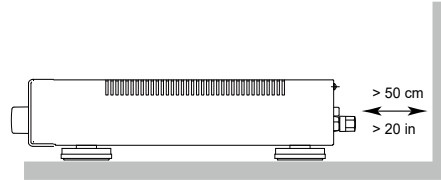

WARNING: The rear panel power cord connector is the mains power disconnect device. The device must be located in an open area that allows access to the cord connector.

The unit must be connected to a power supply only of the type and voltage specified on the side panel. (USA: 120 V/60Hz, EC: 230V/50Hz)

Connect the component to the power outlet only with the supplied power supply cable or an exact equivalent. Do not modify the supplied cable. Do not use extension cords.

The main plug is the disconnect of the unit. In order to completely disconnect the unit from the supply mains, remove the main plug from the unit and the AC power outlet. This is the only way to completely remove mains power from the unit.

Use Class 2 wiring for speaker connections to ensure proper installation and minimize the risk of electrical shock.

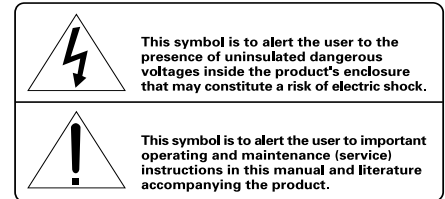
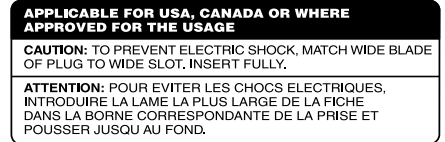

Rotel products are designed to comply with international directives on the Restriction of Hazardous Substances (RoHS) in electrical and electronic equipment and the disposal of Waste Electrical and Electronic Equipment (WEEE). The crossed wheellie bin symbol indicates compliance and that the products must be appropriately recycled or processed in accordance with these directives.



Figure 1-1: Controls and Connections
 Commandes et branchements
 Bedienelemente und Anschlüsse
 Controles y Conexiones

Bedieningselementen en aansluitingen
 Controlli e connessioni
 Kontrollor och kontakter
 Органы управления и разъемы

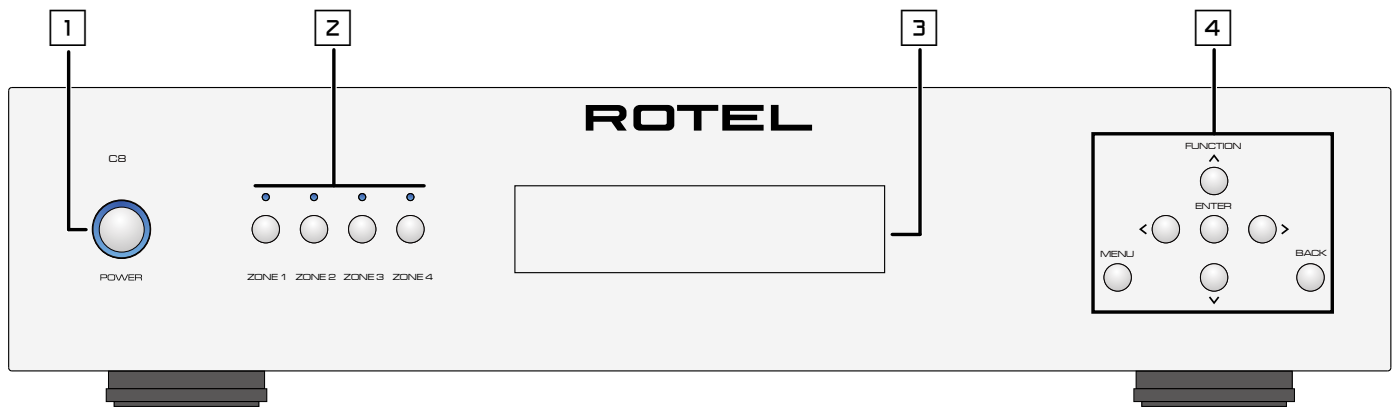

1: Power Button
 Activate the unit or put it into standby mode

2: ZONE 1 - 4
 Configure the volume, source, bass treble and balance for Zone 1 to Zone 4 respectively.

3: Display

4: Function Buttons
 Navigating and ENTER Buttons
 MENU Button
 BACK Button

Figure 1-2: Controls and Connections
 Commandes et branchements
 Bedienelemente und Anschlüsse
 Controles y Conexiones

Bedieningselementen en aansluitingen
 Controlli e connessioni
 Kontroller och kontakter
 Органы управления и разъемы

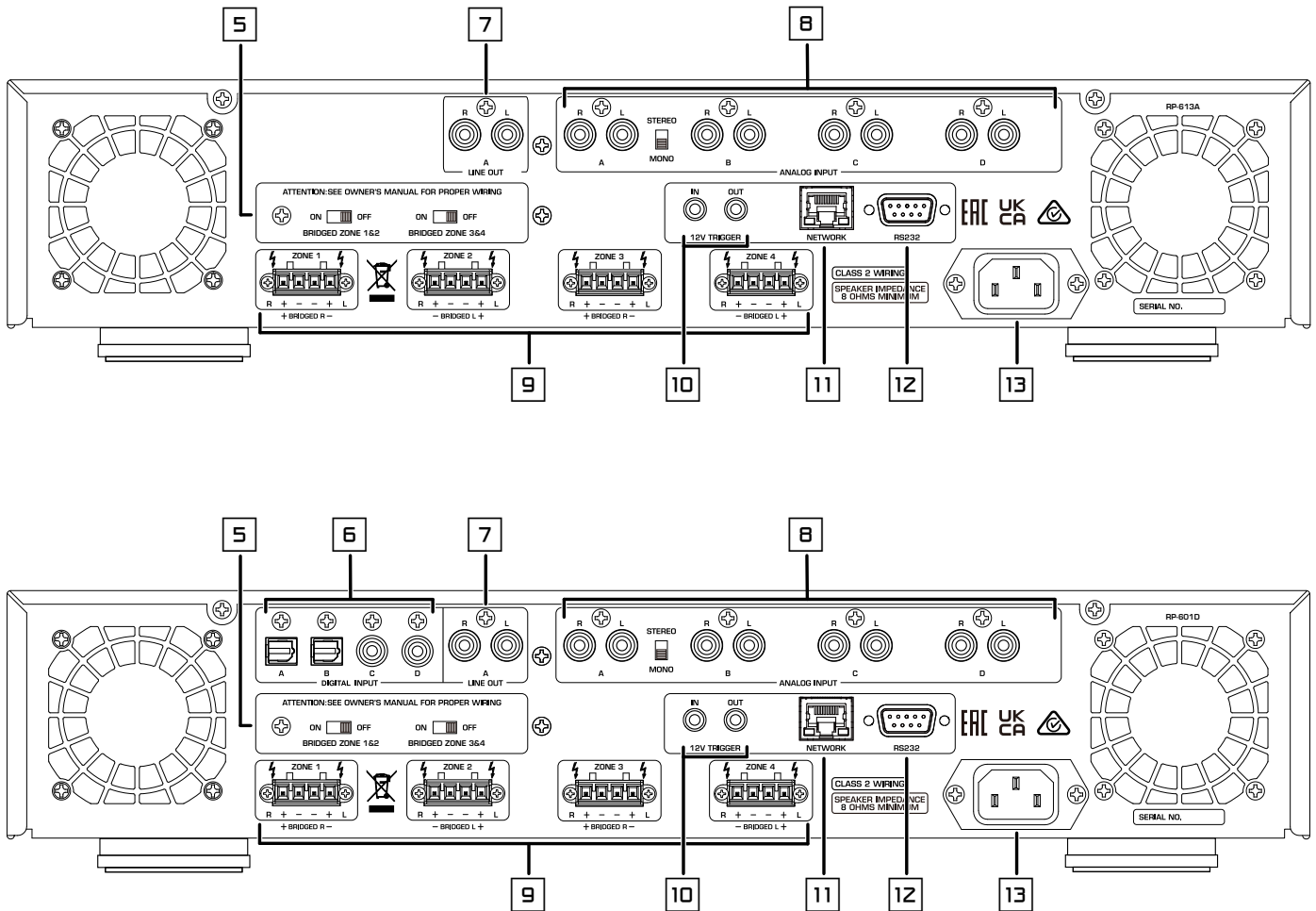

5: Bridged Slide Switches

Allow 2 amplifier channels to be connected providing higher power for larger or more demanding speakers.

6: Digital Input

Use for digital connection.

7: Line Output

Use for live level connection.

8: Analog Input

Use for analog connection.

9: Speaker Connectors

10: 12V Trigger Input and Output

11: Network Port

Use for software updates and integration with automation systems.

12: RS232 Port

Use for integration with automation systems.

13: AC Power Inlet

Figure 2: Connection Illustration
 Schéma de raccordement
 Anschlussdiagramm
 Ilustración del Conexionado

Aansluiten Afbeelding
 Collegamento
 Anslutningar
 Подсоединение - пример

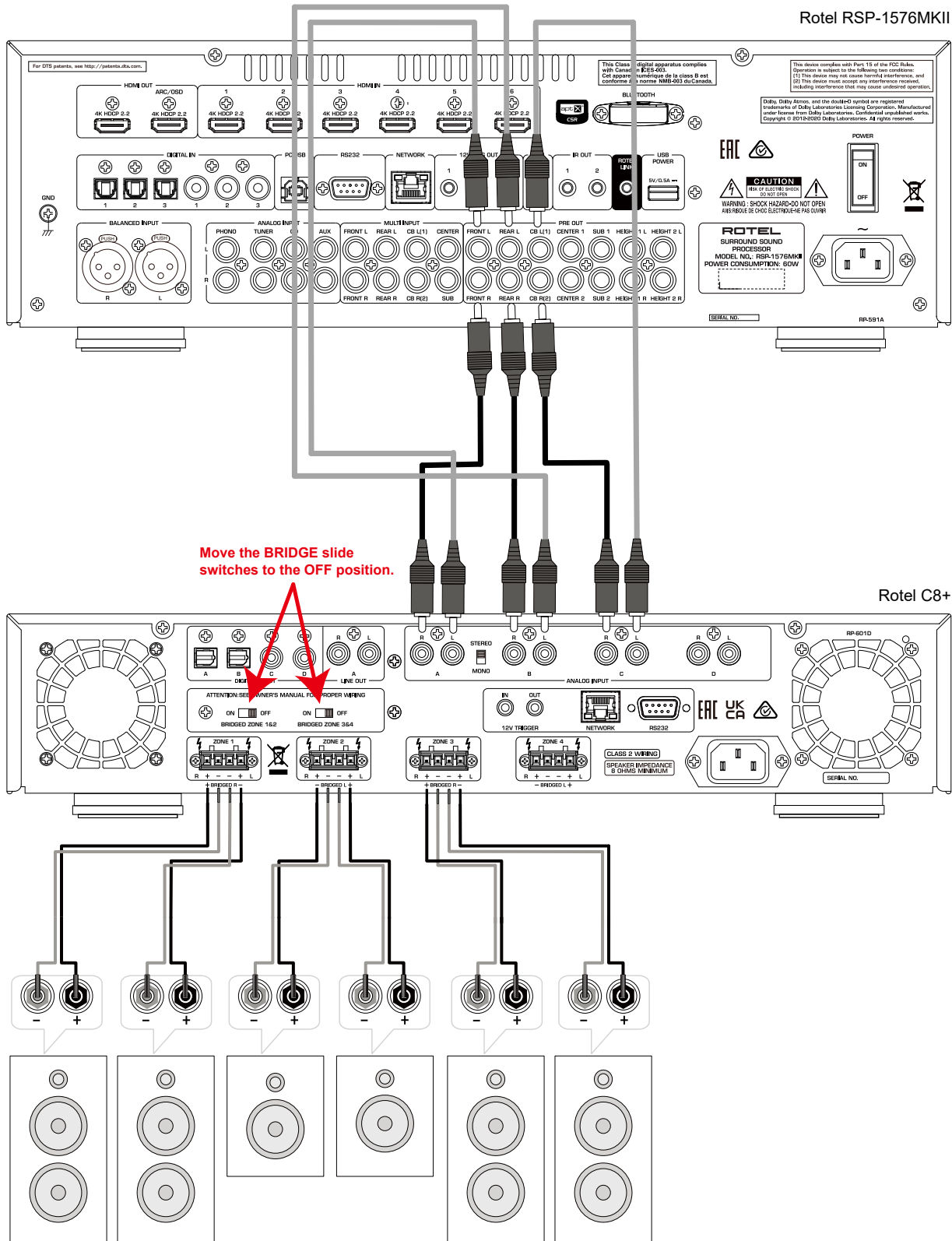
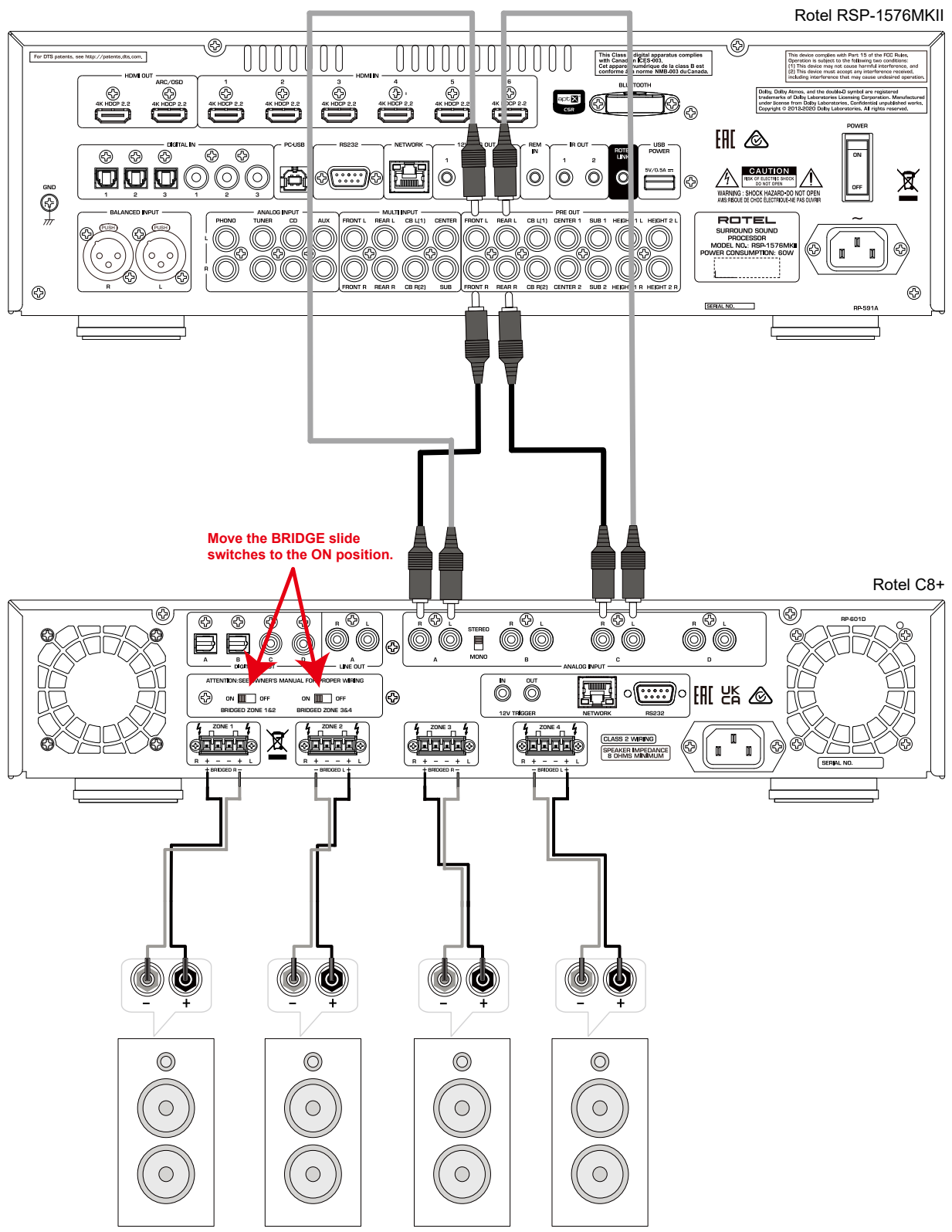

Figure 3: Bridged Connection Illustration
 Schéma de raccordement pontée
 Abbildung der gebrückten Verbindung
 Ilustración del Conexionado en puente

Overbrugde Aansluiten Afbeelding
 Collegamento a ponte
 Överbryggad Anslutningar
 Подсоединение мостового -пример



Important Notes

When making connections be sure to:

- ✓ Turn off all the components in the system before hooking up any components, including loudspeakers.
- ✓ Turn off all components in the system before changing any of the connections to the system.

It is also recommended that you:

- ✓ Turn the volume control of the amplifier all the way down before the amplifier is turned on or off.

Remarques importantes

Pendant les branchements, assurez-vous que :

- ✓ Tous les maillons sont éteints avant leur branchement, quels qu'ils soient, y compris les enceintes acoustiques.
- ✓ Éteignez tous les maillons avant de modifier quoi que ce soit au niveau de leurs branchements, quels qu'ils soient.

Il est également recommandé de :

- ✓ Toujours baissez le niveau sonore via le contrôle de volume, avant d'allumer ou d'éteindre l'amplificateur.

Wichtige Hinweise

Achten Sie beim Herstellen der Verbindungen auf Folgendes:

- ✓ Schalten Sie alle Komponenten im System ab, bevor Sie Geräte (einschließlich Lautsprecher) anschließen.
- ✓ Schalten Sie alle Komponenten im System ab, bevor Sie Anschlüsse im System verändern.

Ferner empfehlen wir, dass

- ✓ Sie die Lautstärke heruntersdrehen, bevor Sie die Endstufe ein- oder abschalten.

Notas Importantes

Cuando realice las conexiones, asegúrese de que:

- ✓ Desactiva todos los componentes del equipo, cajas acústicas incluidas, antes de conectar cualquier nuevo componente en el mismo.
- ✓ Desactiva todos los componentes del equipo antes de cambiar cualquier conexión del mismo.

También le recomendamos que:

- ✓ Reduzca el nivel de volumen de su amplificador a cero antes de activarlo o desactivarlo.

Héél belangrijk

Bij het maken van de verbindingen:

- ✓ Zorg dat niet alleen de C8/C8+ versterkers, maar de gehele installatie uitstaat, als nog niet alle verbindingen gemaakt zijn.
- ✓ Zorg dat niet alleen de C8/C8+ versterkers, maar de gehele installatie ook uitstaat, als u verbindingen gaat wijzigen.

Wij raden u ook aan om

- ✓ de volumeregelaar van de voorversterker geheel dicht te draaien (volkomen naar links) wanneer u uw eindversterker aan- of uitzet.

Note importanti

Quando effettuate i collegamenti assicuratevi di:

- ✓ Spegner tutti i componenti del sistema prima di collegare qualsiasi componente, inclusi i diffusori.
- ✓ Spegner tutti i componenti del sistema prima di modificare qualsiasi connessione nel sistema.

Vi raccomandiamo inoltre di:

- ✓ Portare il volume a zero prima di accendere o spegnere l'amplificatore.

Viktigt

Tänk på följande när du gör anslutningar:

- ✓ Stäng av alla apparater i anläggningen innan du ansluter nya komponenter eller högtalare.
- ✓ Stäng av alla apparater i anläggningen innan du ändrar någon anslutning.

Vi rekommenderar också att du:

- ✓ Vrider ner volymen på förstärkaren helt och hållet innan förstärkaren slås på eller av.

Важные замечания

Перед подсоединением:

- ✓ Выключите **все** компоненты, включая колонки.
- ✓ Выключите **все** компоненты в вашей системе, прежде чем что-то в ней **менять**.

Рекомендуется также:

- ✓ Вывести громкость усилителя на **минимум**, перед тем как **включать или выключать** его.

Contents

Important Safety Instructions	2
Figure 1-1: Controls and Connections	3
Figure 1-2: Controls and Connections	4
Figure 2: Connection Illustration	5
Figure 3: Bridged Connection Illustration	6
Important Notes	7
About Rotel	8
A Word About Watts	8
Getting Started	9
A Few Precautions	9
Placement	9
AC Power and Control	9
AC Power Input ¹³	9
POWER Switch ¹	10
12V Trigger Input and Output ¹⁰	10
Protection Indicator ¹	10
Signal Connections ^{2 3 4}	10
RCA Inputs ^{1 10}	10
Mono Switch ^{1 10}	10
Line Output ⁷	10
Digital Inputs ⁶	10
Speaker Outputs	10
Speaker Selection	10
Speaker Wire Selection	10
Polarity and Phasing	11
Speaker Wire Connections	11
Plug connection ⁹	11
Bridged Connection ⁵	11
Network Connection ¹¹	11
RS232 Connector ¹²	11
Cooling Fan	11
Front Panel Revide	11
Zone 1-4 ²	11
Display ³	12
Function Button ⁴	12
Settings Menu	12
Troubleshooting	13
Power Indicator Is Not Illuminated	13
Fuse Replacement	13
No Sound	13
Playable Audio Formats	13
Specifications	14

About Rotel

Our story began over 60 years ago. Over the decades, we have received hundreds of awards for our products and satisfied hundreds of thousands of people who take their entertainment seriously – like you!

Rotel was founded by a family whose passionate interest in music led them to manufacture high-fidelity components of uncompromising quality. Through the years, that passion has remained undiminished and the family goal of providing exceptional value for audiophiles and music lovers, regardless of their budget, is shared by all Rotel employees.

Rotel's engineers work as a close team, listening to, and fine tuning, each new product until it reaches their exacting musical standards. They are free to choose components from around the world in order to make that product the best they can. You are likely to find capacitors from the United Kingdom and Germany, semiconductors from Japan or the United States, while toroidal power transformers are manufactured in Rotel's own factory.

We all have concerns about our environment. And, as more and more electronics are produced it is especially important for a manufacturer to do all it can to engineer products that have a minimum impact on the environment.

At Rotel, we are proud to do our part. We have reduced the lead content in our products by using special lead-free ROHS solder and components. Our engineers continually strive to improve power supply efficiency without compromise to quality. When in standby mode Rotel products use minimal power to meet global Standby Power Consumption requirements.

The Rotel factory is also doing their part to help the environment through constant improvements to product assembly methods for a cleaner and greener manufacturing processes.

All of us at Rotel thank you for buying this product. We are sure it will bring you many years of enjoyment.

A Word About Watts

The C8 power output is quoted as 70 watts for each channel when all eight channels are operating together at full power into 4 ohms. The C8+ power output is quoted as 150 watts for each channel when all eight channels are operating together at full power into 4 ohms.

Rotel has chosen to specify the power output in this way because, in Rotel's experience, it gives the truest value of the receiver or amplifier's power capability.

When comparing specifications for different products, you should be aware that power output is often specified in other ways, so you may not be comparing like with like. For example, the power output may be quoted with only one channel operating, giving a higher maximum figure.

A loudspeaker's impedance rating indicates the electrical resistance or load it offers when connected to the amplifier, usually 8 ohms or 4 ohms. The lower the impedance, the more power the speaker will need. In effect, a 4 ohm speaker will require twice as much power as an 8 ohm speaker.

However, Rotel amplifiers are designed to work into any speaker impedance between 8 and 4 ohms, and with all the channels working up to their full power. Because the Rotel design is optimized for use with all channels

operating together, Rotel is able to specify the true power output for all channels.

This can be important for your enjoyment, too. When watching movies, it's nice to have the amplifier able to reproduce full power into all the channels at the same time, especially in the case of a volcano exploding!

Getting Started

Thank you for purchasing the Rotel Eight Channel Power Amplifier. When used in a high-quality music audio system, your Rotel product will provide years of musical enjoyment.

This amplifier is a full featured, high performance component. All aspects of the design have been optimized to retain the full dynamic range and subtle nuances of your music. The unit has a highly regulated power supply incorporating a Rotel custom-designed toroidal power transformer. This low impedance power supply has ample power reserves, which enables the amplifier to easily reproduce the most demanding audio signals. This type of design is more expensive to manufacture, but it is better for the music.

The printed circuit boards (PCB) are designed with Symmetrical Circuit Traces. This ensures that the precise timing of the music is maintained and faithfully recreated. The circuitry uses metal film resistors and polystyrene or polypropylene capacitors in important signal paths. All aspects of this design have been examined to ensure the most faithful music reproduction.

The main functions of the amplifier are easy to install and use. If you have experience with other stereo systems, you shouldn't find anything perplexing. Simply plug in the associated components and enjoy.

A Few Precautions

WARNING: *To avoid potential damage to your system, turn off ALL the components in the system when connecting or disconnecting the loudspeakers or any associated components. Do not turn the system components back on until you are sure all the connections are correct and secure. Pay particular attention to the speaker wires. There must be no loose strands that could contact the other speaker wires, or the chassis of the amplifier.*

Please read this manual carefully. In addition to basic installation and operating instructions, it provides valuable information on various unit system configurations as well as general information that will help you get optimum performance from your system. Please contact your authorized Rotel dealer for answers to any questions you might have. In addition, all of us at Rotel welcome your questions and comments.

Save the shipping carton and all enclosed packing material for future use. Shipping or moving the amplifiers in anything other than the original packing material may result in severe damage to your unit.

If included in the box please fill out and send in the owner's registration card. Also be sure to keep the original sales receipt. It is your best record of the date of purchase, which you will need in the event warranty service is ever required.

Placement

Like all audio components that handle low level signals, this amplifier can be affected by its environment. Avoid placing the unit on top of other components. Also avoid routing audio signal cables near power cords. This will minimize the chance it will pick up hum or interference.

The unit generate heat as part of their normal operation. The heat sinks and ventilation openings in the amplifier are designed to dissipate this heat. The amplifier requires 50 cm (20 inches) of clearance around the back side of the chassis. Reasonable airflow in the equipment rack is required to prevent the amplifier from overheating.

Remember the weight of the unit when you select an installation location. If you are not using the included rack ears make sure that the shelf or cabinet used can support the unit. We recommend installing the unit in furniture designed to house audio components. Such furniture is designed to reduce or suppress vibration which can adversely affect sound quality. Ask your authorized Rotel dealer for advice about component furniture and proper installation of audio components.

Cables

Be sure to keep the power cords, digital signal cables and analog audio signal cables in your installation away from each other. This will minimize the chance of the analog audio signal cables picking up noise or interference from the power cords or digital cables. Using only high quality, shielded cables will also help to prevent noise or interference from degrading the sound quality of your system. If you have any questions see your authorized Rotel dealer for advice about the best cable to use with your system.

AC Power and Control



AC Power Input

Your unit is configured at the factory for the proper AC voltage in the country where you purchased it, either 120 volts or 230 volts. The AC line configuration is noted on a label on the side panel.

NOTE: *Should you move your unit to another country, it may be possible to reconfigure it for use on a different line voltage. Do not attempt to perform this conversion yourself. Opening the enclosure of the unit exposes you to dangerous voltages. Consult a qualified service person or the Rotel factory service department for information.*

NOTE: *Some products are intended for sale in more than one country and as such are supplied with more than one AC cord. Please only use the one appropriate for your country/region.*

Because of its high power rating, the unit can draw considerable current. Therefore, it should be plugged directly into a wall outlet. The unit must be plugged into a 3-pin polarized outlet. Do not use an extension cord. A heavy duty multi-tap power outlet strip may be used if it (and the wall outlet) is rated to handle the current demanded by the unit and all the other components connected to it.

Be sure the POWER SWITCH  on the front panel of the unit is turned off (in the "out" position). Then, connect the supplied power cord to the Power Connector  on the rear of the unit and the AC power outlet.

If you are going to be away from home for an extended period of time such as a month-long vacation, it is a sensible precaution to unplug your unit (as well as other audio and video components) while you are away.

Power Switch and Power Indicator 1

The power switch is located on the front panel of your amplifier. To turn the unit on, push the switch in. The ring around the switch will light up and blink three times, indicating that the amplifier is turned on. To turn the amplifier off, push the button again and return it to the "out" position.

12V Trigger Input and Output 10

The jack labeled IN is for connecting the 3.5mm mono plug/cable carrying a +12 volt trigger signal to turn the amplifier on and off. This input accepts any control signal (AC or DC) ranging from 3 volts to 30 volts.

The jack labeled OUT is for connecting another 3.5mm mono plug/cable to provide a 12 volt trigger signal to other components. Any 12V Trigger signal at the INPUT jack will be passed through to the OUT jack.

NOTE: The maximum current for the trigger out is 10mA.

Protection Indicator 1

The amplifier has both thermal and over-current protection circuitry that protects the amplifier against damage in the event of extreme or faulty operating conditions. The protection circuits are independent of the audio signal and have no impact on sonic performance. Instead, the protection circuits monitor the temperature of the output devices and shut down the amplifier if temperatures exceed safe limits.

Most likely, you will never see this protection circuitry in action. However, should a faulty condition arise, the amplifier will stop playing. The power indicator 1 on the front panel will blink. The LEDs above the ZONE 1 - 4 also will blink to indicate which zone caused the protection.

If this happens, turn the amplifier off. Let it cool down for several minutes, and attempt to identify and correct the problem that caused the protection circuitry to engage. When you turn the amplifier back on, the protection circuit will automatically reset and the power indicator 1 as well as the LEDs above the ZONE 1 - 4 should light up, indicating that the amplifier is turned on normal.

In most cases, the protection circuitry activates because of a fault condition such as shorted speaker wires, or inadequate ventilation leading to an overheating condition. In very rare cases, highly reactive or extremely low impedance speaker loads could cause the protection circuit to engage.

If the protection circuitry triggers repeatedly and you are unable to isolate and correct the faulty condition, contact your authorized Rotel dealer for assistance in troubleshooting.

Signal Connections

See Figure 2

NOTE: To prevent loud noises that neither you nor your speakers will appreciate, make sure the system is turned off when you make any signal connections.

The unit provides standard RCA type input connections as found on nearly all audio equipment.

In addition to the four groups of stereo inputs labeled ANALOG INPUT A to D, there is also a pair of LINE OUT connections for passing the signal connected to the unit to another audio component.

Analog Inputs 8

There are four Analog inputs for each of the four pairs of unit channels. These Analog inputs accept audio signals from preamplifiers or surround sound processors. Select high quality audio interconnect cables for best performance.

For each pair of amplifier channels, connect the left channel output of your preamp to the LEFT INPUT on the amplifier. Connect the right channel of your preamp to the RIGHT INPUT. Make sure that the input A slide switch to the upside of the analog inputs is in the STEREO position.

Mono Switch 8

For the channel INPUT A, when the input A slide switch is moved to the MONO position, the left and right signals are combined and provided to both speakers as a mono signal.

Line Output 7

This pair of Line level connections can be used to pass unprocessed input signals to another audio component, for example to "daisy-chain" to another amplifier to drive additional speakers. The input signals connected to the INPUT A connectors is available on the Line Output connectors. This is typically used when the unit is part of a multi-room system.

NOTE: It is recommended to Daisy Chain a maximum of 8 units.

NOTE: The MONO switch does not affect the Line Output.

Digital Inputs 6

For C8+ Only

There are two sets of digital inputs labeled DIGITAL INPUT A to D. Connect the DIGITAL outputs of your source component into these sockets. The digital signals will be decoded and played by the amplifier. The unit is capable of decoding PCM signals up to 24 bit, 192kHz.

Speaker Outputs

See figure 2

The unit has four pairs of speaker connectors, one for each amplifier channel. The eight speaker connectors may be used in many different configurations. The Hook-up Illustration, Figure 2, shows just one example, with the connections for a typical six-speaker system. Here, the remaining two channels are still available to power up to two more speakers as required.

Speaker Selection

We recommend using loudspeakers with a nominal impedance of 4 ohms or higher with the unit. You should not drive more than one pair of speakers for each output channel. Driving more than one set of speakers from an output may damage the unit. Speaker impedance ratings are less than precise. In practice, very few loudspeakers will present any problems for the unit. See your authorized Rotel dealer if you have any questions.

Speaker Wire Selection

Use insulated two-conductor stranded wire to connect the unit to the speakers. The size and quality of the wire can have an audible effect on the performance of the system. Standard speaker wire will work, but can result in lower output or diminished bass response, particularly over longer distances. In general, heavier wire will improve the sound. For best performance, you may want to consider special high-quality speaker cables. Your authorized Rotel dealer can help in the selection of cables for your system.

Polarity and Phasing

The polarity – the positive/negative orientation of the connections – for every speaker and amplifier connection must be consistent so all the speakers will be in phase. If the polarity of one connection is reversed, bass output will be very weak and stereo imaging degraded. All wire is marked so you can identify the two conductors. There may be ribs or a stripe on the insulation of one conductor. The wire may have clear insulation with different color conductors (copper and silver). There may be polarity indications printed on the insulation. Identify the positive and negative conductors and be consistent with every speaker and amplifier connection.

Speaker Wire Connections

Turn off all the components in the system before connecting the speakers.

Route the wire from the unit to the speakers. Give yourself enough slack so you can move the components to allow access to the speaker connectors.

For each group of channels, connect the left speaker to the pair of speaker connectors labeled LEFT. Connect the right speaker to the speaker connectors labeled RIGHT. Make sure that the positive terminal of the speaker is connected to the + terminal on the unit. Make sure that the negative terminal of the speaker is connected to the terminal of the unit.

NOTE: Be sure there are no loose wire strands that could touch adjacent wires or connectors.

Plug connection 9

Connect the speaker wires as shown in the illustration. Insert the wire into the opening and turn the screw to clamp the wire in place.

Be sure to keep the polarity of the connections correct. Speaker connectors can be secured to the unit using the secure-locking screws on each side of the connector. This will help prevent the connectors from falling out from the socket.

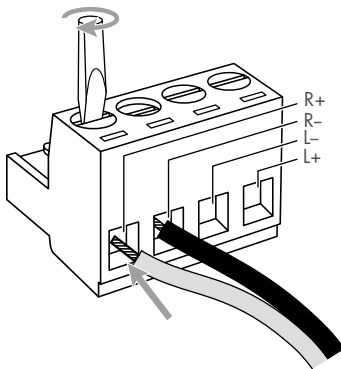

Bridged Speaker Outputs Connection 5

See figure 3

Bridging allows 2 amplifier channels to be connected providing higher power for larger or more demanding speakers. To enable the bridging function slide the BRIDGE ZONE 1&2 or BRIDGE ZONE 3&4 slide switch 5 to the ON position.

When bridged use the Left and Right input for Input A (Zone 1 and 2 bridged) or the Input C (Zone 3 and 4 bridged).

Speaker output connections must follow the diagram found in Figure 3 to ensure output power is properly wired from the unit to the speakers.

NOTE: Failure to following the bridging speaker wiring diagram will result in inefficient output and will not properly bridge the amplifier channels together.

Network Connection 11

The amplifier can be attached to a network using the rear panel NETWORK socket 11. The NETWORK configurations allow both STATIC and DHCP IP addressing. See the Network section of this manual under Setting Menu for IP address configuration information.

The NETWORK connection allows software updates to be downloaded from the Internet. The NETWORK connection also allows IP control for integration with automation systems.

For additional information on the IP control please contact your authorized Rotel dealer.

RS232 Connector 12

The unit can be controlled via RS232 for integration with automation systems. The RS232 input accepts a standard STRAIGHT DB-9 Male-to-Female cable.

For additional information on the connections, software, and operating codes for RS232 control of the amplifier, contact your authorized Rotel dealer.

Cooling Fans

The amplifier includes 2 cooling fans to help exhaust the heat generated by the power supply and amplifier modules. These fans will operate when internal thermostat sensors detect cooling is required. The fan speed will increase as needed when the unit temperature increases as detected by the internal sensors.

NOTE: If the cooling fans and cooling tunnels require cleaning please contact your authorized Rotel dealer for more information.

Front Panel Overview

The following is a brief overview of the controls and features on the front panel of the unit.

ZONE 1-4 2

The unit can control the volume, source, bass treble and balance for Zone 1 to Zone 4 respectively. Press the ZONE 1 - 4 buttons to toggle between the menus and use the $\vee/\wedge/\lt;/\gt$ arrow buttons to change the value. Press and hold any ZONE 1 - 4 buttons can mute the source from the corresponding ZONE 1 - 4.

VOLUME: 0 ~ 96. Default: 45.

SOURCE: INPUT A, INPUT B, INPUT C, INPUT D.

BASS: -10 ~ +10. Default: 0.

TREBLE: -10 ~ +10.Default: 0.

BALANCE: L10 ~ R10.Default: 0.

Display 3

The front panel display shows the source selected, volume level and tone settings. The display provides access to the setup and configuration menu options of the unit and can be dimmed using the setup menu.

Function Button 4

Navigating and ENTER Buttons: Use the navigation $\vee/\wedge/\langle/\rangle$ buttons and the ENTER on the remote control to access the various menus and operate the unit settings.

MENU Button: The MENU button activates the setup screen on the front display. Push the MENU button again to exit setup menu and go back to normal display.

BACK Button: Pressing briefly returns to the previous selection screen.

Settings Menu

You can access the SETUP menu from the front panel by pressing the MENU 4 button. You can change the value of the selected option by pressing the \langle/\rangle 4 arrow buttons on the front panel. Step through the sub-menus by pressing the ENTER 4 button on the front panel.

- INPUT SOURCE: Configure the source to the INPUT A, B, C and D.

Valid settings include: AUTO (Default), ANALOG, DIGITAL.

NOTE: When both analog and digital source are connected to the unit, the unit will select the digital source as a priority if there is a clocking signal or audio if set to AUTO.

- ZONE SOURCE: Configure the source input for Zone 1 - 4 as fixed or Matrix-ed from all available source inputs.

Valid settings include: MATRIX (Default), INPUT A, INPUT B, INPUT C, INPUT D.

NOTE: When set to MATRIX the front panel ZONE 1 - 4 buttons 2 allow section of the source input A - D.

- INPUT NAME: The name of the sources A - D can be customized. For example INPUT A can be named "MUSIC" for easier reference. Press the ENTER button to enter the source name edit sub menu as below. The maximum source name is limited to 10 characters.

Name: _____
-0123456789ABCD
EFGHIJKLMNOPQRST
UVWXYZ DEL DONE

- ZONE NAME: The name of the Zones 1-4 can be customized. For example ZONE 1 can be named "AUDIO" for easier reference. Press the ENTER button to enter the source name edit sub menu as below. The maximum source name is limited to 6 characters.

Name: _____
-0123456789ABCD
EFGHIJKLMNOPQRST
UVWXYZ DEL DONE

- MAX VOLUME: This sets the maximum volume level for ZONE 1 - 4. "75" is the factory default. Max volume limits the volume level using the front panel Zone 1 - 4 controls.

Valid settings include: 0 ~ 96. Default: 75.

- LCD DIMMER: Dims the front LCD display.

Valid settings include: HIGH (Default), MEDIUM HIGH, MEDIUM, MEDIUM LOW and LOW.

- LED DIMMER: Dims the Power LED on the front panel.

Valid settings include: HIGH (Default), MEDIUM and LOW.

- DISPLAY OPTION: Configures the front panel to always be on or turn off after a timeout period. The front panel will always activate during power on and when the front panel controls are used until the timeout period expires. Use the TIMEOUT function if you do not want the front panel displayed during normal operation.

Valid settings include: ON (Default), 5 SEC TIMEOUT, 10 SEC TIMEOUT.

- AUTO POWER OFF: The unit can be configured to automatically power off if there is no active audio playing in a zone and the unit is unused for a specified period. If the audio signal on all active Zones stops and no changes are made to the unit within the specified period, the unit will automatically go to STANDBY mode. The auto power off timer will be restarted if audio is detected or if changes are made to the volume, source or playback. The default is set to 20 MINS.

Valid settings include: 20MINS (Default), DISABLE, 1 HOUR, 2 HOURS, 5 HOURS, 12 HOURS.

NOTE: When the 12V Trigger is connected the AUTO POWER OFF function is disabled and the Trigger given priority to control STANDBY power.

- AC POWER OPTION: If set to ON the unit will be powered on when AC Power is connected and the front panel power button is depressed to the on position. If set to STANDBY the unit will enter Standby mode when AC Power is connected and the front panel power button is depressed.

This function is useful to identify the operation of the unit in the event of a power failure and restore. The unit will either resume operation in the ON state or will enter STANDBY after a power failure/restore.

Valid settings include: ON (Default), STANDBY.

- PA OVERRIDE: Enable INPUT A as PA Override signal input. When an audio signal is detected on Input Source A the audio will immediately be broadcast to all Zones 1 - 4. The unit will resume the previous Source Input after approximately 10 seconds of no audio on the INPUT A source.

Valid settings include: DISABLED (Default), ENABLED.

- **PA OVERRIDE VOL:** This sets the volume level of ZONE 1 - 4 when the PA OVERRIDE function is activated. "45" is the factory default.

Valid settings include: 0 ~ 96. Default: 45.

- **NETWORK WAKEUP:** When set to Enabled the unit will maintain the Ethernet IP connection even in Standby Mode allowing the unit to be powered on via IP. If Disabled the unit will not power on from the IP connection and must use either the front panel or RS232 to power on the unit.

Valid settings Include: DISABLED (Default), ENABLED.

NOTE: When Network Standby is enabled the unit will consume additional power.

- **NETWORK SETUP:** In most systems, set the IP ADDRESS MODE to DHCP. This setting will allow your router to assign an IP address to the unit automatically. If your network uses fixed IP addresses, set the IP ADDRESS MODE to STATIC.

Valid settings Include: DHCP (Default), STATIC.

If STATIC mode is selected you must configure all settings for the network including IP Address, Subnet Mask, Gateway and DNS Server. Press the ENTER button to activate the first digit in the line you want to change, then use the </> buttons to adjust the values and press the ENTER button to cycle to the next digit. When the proper IP information is configured press the ENTER button to move the cursor back to the previous menu and accept the settings. After entering the STATIC IP address information the network will be tested and connection status reported.

NOTE: For more information regarding network connection please contact your authorized Rotel dealer.

NOTE: A network connection is not required for the unit to operate.

- **NETWORK INFO:** Shows the network information. Press the ENTER button to view Network Connection Status, IP Address, Subnet Mask, Gateway and MAC Address.
- **SOFTWARE VERSION:** This shows the current software version loaded into the unit.
- **SOFTWARE UPDATED:** The software can be updated if the unit is properly connected to the Internet.
 - Press the ENTER button on the front panel to check if a new software version is available.
 - If a new software version is available, use </> arrow buttons to select "UPDATE" option and press the ENTER button to begin the software update process.
 - The new software will be downloaded from the Internet. The amplifier will power cycle when the software update is complete.

NOTE: Do NOT power off the unit during the software update process.

NOTE: It is recommended to Reset Factory Defaults after the software update is complete.

- **FACTORY DEFAULT:** This sets the unit back to the original state as when it left the factory. Press the ENTER button on the front panel to enter factory reset menu. Use the ^ / ~ arrow buttons to select YES and press the ENTER button again to begin reset, or select NO to cancel.

NOTE: All previously configured options will be erased and reset to the factory default settings.

- **EXIT:** Exits this SETUP menu.

Troubleshooting

Most difficulties in audio systems are the result of incorrect connections, or improper control settings. If you encounter problems, isolate the area of the difficulty, check the control settings, determine the cause of the fault and make the necessary changes. If you are unable to get sound from the unit, refer to the suggestions for the following conditions:

Power Indicator Is Not Illuminated

The Power Indicator and the basic items in the Display window should be illuminated whenever the unit is plugged into the wall power outlet and the Power button is pushed in. If it does not illuminate, test the power outlet with another electrical device, such as a lamp. Be sure the power outlet being used is not controlled by a switch that has been turned off. If using 12V trigger power-on, make sure that a trigger signal is present at rear panel 12V TRIGGER IN connector.

Fuse Replacement

If another electrical device works when plugged into the power outlet, but the Power Indicator still will not illuminate when the unit is plugged into the wall outlet, it indicates that the internal power fuse may have blown. If you believe this has happened, contact your authorized Rotel dealer to get the fuse replaced.

No Sound

Check the signal source to see if it is functioning properly. Make sure the cables from the signal source to the amplifier inputs are connected properly. Be sure the Input Source is set to the proper input. Check the wiring between the amplifier and the speakers.

Playable Audio Formats

Optical

Format	Notes
SPDIF LPCM	44.1k, 48k, 88.2k, 96k, 176.4k, 192k 16 bit, 24 bit

Specifications

C8		C8+	
Max Power output	70 watts / channel (8 channels driven, 4 ohms)	Max Power output	150 watts / channel (8 channels driven, 4 ohms)
Continuous Power Output	50 watts / channel (8 channels driven, 8 ohms)	Continuous Power Output	100 watts / channel (8 channels driven, 8 ohms)
Bridged Power Output	140 watts / channel (4 channels driven, 4 ohms)	Bridged Power Output	300 watts / channel (4 channels driven, 4 ohms)
Total Harmonic Distortion	< 0.1%	Total Harmonic Distortion	< 0.1%
Intermodulation Distortion (60 Hz : 7k Hz, 4:1)	< 0.1%	Intermodulation Distortion (60 Hz : 7k Hz, 4:1)	< 0.1%
Frequency Response		Frequency Response	
Line level Input	10 Hz - 100k Hz, +/- 0.5 dB	Line level Input	10 Hz - 100k Hz, +/- 0.5 dB
Tone Control		Tone Control	
Bass	±10dB at 100Hz	Bass	±10dB at 100Hz
Treble	±10dB at 10kHz	Treble	±10dB at 10kHz
Damping Factor (20 Hz – 20k Hz, 8 ohms)	80	Damping Factor (20 Hz – 20k Hz, 8 ohms)	80
Input Sensitivity / Impedance		Input Sensitivity / Impedance	
Line level Input (RCA)	0.3 V / 31k ohms	Line level Input (RCA)	0.43 V / 31k ohms
Input Overload		Input Overload	
Line level Input (RCA)	2.8 V	Line level Input (RCA)	2.8 V
Signal to Noise Ratio (A weighting)		Signal to Noise Ratio (A weighting)	
Line level Input (RCA)	100 dB	Line level Input (RCA)	100 dB
Crosstalk / Separation	> 50 dB	Crosstalk / Separation	> 50 dB
General		Digital	
Power Requirements:		Frequency Response	10 Hz - 20k Hz, +/- 0.5 dB
USA:	120 Volts, 60 Hz	Signal to Noise Ratio (A weighting)	102 dB
EC:	230 Volts, 50 Hz	Input Sensitivity / Impedance	0 dBFS / 75 ohms
Power Consumption	570 watts	Digital Inputs	SPDIF LPCM (up to 192kHz 24bit)
Standby Power Consumption		General	
Normal	< 0.5 watts	Power Requirements:	
Network Wakeup	< 2 watts	USA:	120 Volts, 60 Hz
BTU (4 ohms, 1/8th power)	1537 BTU/h	EC:	230 Volts, 50 Hz
Dimensions (W x H x D)	430 x 97 x 414 mm (17 x 3 7/8 x 16 2/7 ins)	Power Consumption	980 watts
Front Panel Height	2U (88.1 mm, 3 1/2 ins)	Standby Power Consumption	
Weight (net)	16.7 kg, 36.81 lbs.	Normal	< 0.5 watts
		Network Wakeup	< 2 watts
		BTU (4 ohms, 1/8th power)	2744 BTU/h
		Dimensions (W x H x D)	430 x 97 x 414 mm (17 x 3 7/8 x 16 2/7 ins)
		Front Panel Height	2U (88.1 mm, 3 1/2 ins)
		Weight (net)	18.35 kg, 40.79 lbs.

All specifications are accurate at the time of printing.
 Rotel reserves the right to make improvements without notice.

Rotel and the Rotel Hi-Fi logo are registered trademarks of The Rotel Co., Ltd, Tokyo, Japan.



ROTEL®

The Rotel Co. Ltd.

Tachikawa Bldg. 1F,
2-11-4, Nakane, Meguro-ku,
Tokyo, 152-0031
Japan

Rotel USA

Sumiko
11763 95th Avenue North
Maple Grove, MN 55369
USA
Phone: (510) 843-4500 (option 2)
E-mail: Rotelsupport@sumikoaudio.net

Rotel Canada

Kevro International
902 McKay Rd. Suite 4
Pickering, ON L1W 3X8
Canada
Tel: +1 905-428-2800

Rotel Europe

Dale Road
Worthing, West Sussex BN11 2BH
England
Phone: + 44 (0)1903 221 710
Fax: +44 (0)1903 221 525

www.rotel.com